

## Copyright Information

Copyright © 2019 LAUNCH TECH CO., LTD. All rights reserved. No part of this publication may be reproduced, stored in a retrieval system, or transmitted in any form or by any means, electronic, mechanical, photocopying, recording or otherwise, without the prior written permission of LAUNCH. The information contained herein is designed only for the use of this unit. LAUNCH is not responsible for any use of this information as applied to other units.

Neither LAUNCH nor its affiliates shall be liable to the purchaser of this unit or third parties for damages, losses, costs, or expenses incurred by purchaser or third parties as a result of: Accident, misuse, or abuse of this unit, or unauthorized modifications, repairs, or alterations to this unit, or failure to strictly comply with LAUNCH operating and maintenance instructions. LAUNCH shall not be liable for any damages or problems arising from the use of any options or any consumable products other than those designated as Original LAUNCH Products or LAUNCH Approved Products by LAUNCH.

LAUNCH owns the complete intellectual property rights for the software used by this product. For any reverse engineering or cracking actions against the software, LAUNCH will block the use of this product and reserve the right to pursue their legal liabilities.

All information, specifications and illustrations in this manual are based on the latest information available at the time of printing.

LAUNCH reserves the right to make changes at any time without notice. While information of this manual has been carefully checked for accuracy, no guarantee is given for the completeness and correctness of the contents, including but not limited to the product specifications, functions, and illustrations. LAUNCH will not be liable for any direct, special, incidental, indirect damages or any economic consequential damages (including the loss of profits).

## Trademark Information

LAUNCH is a registered trademark of LAUNCH TECH CO., LTD. (LAUNCH) in China and other countries. All other LAUNCH trademarks, service marks, domain names, logos, and company names referred to in this manual are either trademarks, registered trademarks, service marks, domain names, logos, company names of or are otherwise the property of LAUNCH or its affiliates. In countries where any of the LAUNCH trademarks, service marks, domain names, logos and company names are not registered, LAUNCH claims other rights associated with unregistered trademarks, service marks, domain names, logos, and company names. Other products or company names referred to in this manual may be trademarks of their respective owners. You may not use any trademark, service mark, domain name, logo, or company name of LAUNCH or any third party without permission from the owner of the applicable trademark, service mark, domain name, logo, or company name. You may contact LAUNCH by visiting the website at [www.cnlaunch.com](http://www.cnlaunch.com), or writing to LAUNCH TECH CO., LTD., Launch Industrial Park, North of Wuhe Avenue, Banxuegang, Bantian, Longgang, Shenzhen, Guangdong, P.R.China, to request written permission to use Materials on this manual for purposes or for all other questions relating to this manual.

## IMPORTANT SAFETY INFORMATION

### DANGER

When an engine is operating, keep the service area well-ventilated or attach a building exhaust removal system to the engine exhaust system. Engines produce various poisonous compounds (hydrocarbon, carbon monoxide, nitrogen oxides, etc.) that cause slower reaction time and result in death or serious personal injury.

### WARNING

**Read all safety warnings and instructions.**

---

\*Note: Failure to follow the warnings and instructions may result in electric shock, fire and/or serious injury.

---

1. Always perform automotive testing in a safe environment.
2. Do not connect or disconnect any test equipment while the ignition is on or the engine is running.
3. **DO NOT attempt to operate the tool while driving the vehicle. Have second person operate the tool. Any distraction may cause an accident.**
4. Before starting the engine, put the gear lever in the Neutral position (for manual transmission) or in the Park (for automatic transmission) position to avoid injury.
5. NEVER smoke or allow a spark or flame in vicinity of battery or engine. Do not operate the tool in explosive atmospheres, such as in the presence of flammable liquids, gases, or heavy dust.
6. Keep a fire extinguisher suitable for gasoline/chemical/electrical fires nearby.
7. Wear an ANSI-approved eye shield when testing or repairing vehicles.
8. Put blocks in front of the drive wheels and never leave the vehicle unattended while testing.
9. Use extreme caution when working around the ignition coil, distributor cap, ignition wires and spark plugs. These components create hazardous voltage when the engine is running.
10. To avoid damaging the tool or generating false data, please make sure the vehicle battery is fully charged and the connection to the vehicle DLC (Data Link Connector) is clear and secure.
11. Automotive batteries contain sulfuric acid that is harmful to skin. In operation, direct contact with the automotive batteries should be avoided. Keep the ignition sources away from the battery at all times.
12. Keep the tool dry, clean, free from oil, water or grease. Use a mild detergent on a clean cloth to clear the outside of the equipment when necessary.
13. Keep clothing, hair, hands, tools, test equipment, etc. away from all moving or hot engine parts.
14. Store the tool and accessories in a locked area out of the reach of children.
15. Do not use the tool while standing in water.
16. Do not expose the tool or power adaptor to rain or wet conditions. Water entering the tool or power adaptor increases the risk of electric shock.

## Using This Manual

This manual contains device usage instructions.

Some illustrations shown in this manual may contain modules and optional equipment that are not included in your system.

### Conventions

The following conventions are used.

#### **Bold Text**

Bold text is used to highlight selectable items such as buttons and menu options.

Example:

Tap **OK**.

#### **Notes and Important Messages**

##### **Notes**

A NOTE provides helpful information such as additional explanations, tips, and comments.

Example:



Note: In general, vehicle identification numbers are standardized - all contain 17 characters. VIN characters may be capital letters A through Z and numbers 1 through 0; however, the letters I, O and Q are never used in order to avoid mistakes of misreading. No signs or spaces are allowed in the VIN.

---

##### **Warning**

WARNING indicates a hazardous situation which, if not avoided, could result in minor or moderate injury to the operator or to bystanders.

Example:



Warning: Retrieving and using DTCs for troubleshooting vehicle operation is only one part of an overall diagnostic strategy. Never replace a part based only on the DTC definition. Each DTC has a set of testing procedures, instructions and flow charts that must be followed to confirm the location of the problem. This information can be found in the vehicle's service manual.

---

##### **Danger**

DANGER indicates an imminently or potentially hazardous situation which, if not avoided, could result in death or serious injury to the operator or to bystanders.

Example:



Danger: If you must drive the vehicle in order to perform a troubleshooting procedure, always have a second person help you. Trying to drive and operate the diagnostic tool at the same time is dangerous, and could cause a serious traffic accident.

---

##### **Hyperlink**

Hyperlinks, or links, that take you to other related articles, procedures, and illustrations are available in electronic documents. Blue italic text indicates a selectable hyperlink and blue underlined text indicates a website link or an email address link.

##### **Illustrations**

Illustrations used in this manual are samples, the actual testing screen may vary for each vehicle being tested. Observe the menu titles and on-screen instructions to make correct option selection.

## Table of Contents

<b>1 Introduction.....</b>	<b>1</b>
1.1 Product Profile .....	1
1.2 Accessory Checklist.....	2
<b>2 Components &amp; Controls .....</b>	<b>4</b>
2.1 Display Tablet .....	4
2.2 SmartLink C Device.....	6
2.3 Technical Specifications .....	7
<b>3 Preparations.....</b>	<b>8</b>
3.1 Charging the Tablet .....	8
3.2 Power ON/OFF .....	8
3.3 Locator & Navigation Buttons.....	8
3.4 Wi-Fi Setup.....	9
3.5 Adjust Brightness.....	10
3.6 Change System Language .....	10
3.7 Set Standby Time .....	10
<b>4 Initial Use.....</b>	<b>11</b>
4.1 Register & Download Diagnostic Software.....	11
4.2 Job Menu.....	13
4.3 Connections.....	14
4.3.1 Preparation .....	14
4.3.2 DLC Location.....	14
4.3.3 Vehicle Connection.....	15
4.4 Communication Setup .....	15
<b>5 Start Diagnostics .....</b>	<b>17</b>
5.1 Intelligent Diagnose .....	17
5.2 Local Diagnose.....	20
5.2.1 Main Menu.....	20
5.2.2 VINSCAN .....	21
5.2.3 Manual Selection.....	22
5.3 Diagnostic History.....	31
5.4 Feedback.....	32
<b>6 Maintenance Reset.....</b>	<b>33</b>
6.1 Oil Reset Service.....	33
6.2 Electronic Parking Brake Reset.....	34
6.3 Steering Angle Calibration .....	34
6.4 ABS Bleeding.....	34
6.5 Tire Pressure Monitor System Reset.....	34
6.6 Gear Learning.....	34
6.7 IMMO Service.....	34
6.8 Injector Coding .....	35
6.9 Battery Maintenance System Reset .....	35

6.10 Diesel Particulate Filter (DPF) Regeneration .....	35
6.11 Electronic Throttle Position Reset .....	35
6.12 Gearbox Matching .....	35
6.13 AFS (Adaptive Front-lighting System) Reset .....	36
6.14 Sunroof Initialization .....	36
6.15 Suspension Calibration .....	36
6.16 EGR Adaption.....	36
6.17 Seats Calibration .....	36
6.18 Tyre Reset .....	36
6.19 Coolant Bleed .....	36
6.20 AdBlue Reset (Diesel Engine Exhaust Gas Filter).....	36
6.21 NOx Sensor Reset.....	36
<b>7 Software Update .....</b>	<b>37</b>
7.1 Update Diagnostic Software & APP.....	37
7.2 Update Frequently Used Software .....	37
7.3 Renew Subscription.....	38
<b>8 SmartLink Diag. ....</b>	<b>39</b>
8.1 Introduction.....	39
8.2 Perform SmartLink Remote Operation .....	41
8.2.1 Posting remote assistance request .....	41
8.2.2 Connections & operations .....	42
<b>9 TPMS.....</b>	<b>45</b>
9.1 Working Principle.....	45
9.2 Operation Flowchart .....	46
9.3 Binding/Unbinding .....	47
9.3.1 Binding .....	47
9.3.2 Unbinding .....	48
<b>10 ADAS .....</b>	<b>49</b>
<b>11 User Info .....</b>	<b>51</b>
11.1 My Report .....	51
11.2 VCI.....	52
11.3 Activate VCI .....	52
11.4 Fix connector firmware/system.....	52
11.5 Data Stream Sample .....	52
11.6 Vehicle Voltage .....	52
11.7 My Order.....	53
11.8 Subscription Renewal Card .....	53
11.9 Profile.....	53
11.10 Change Password .....	53
11.11 Settings .....	53
11.11.1 Units.....	53
11.11.2 Shop Information.....	53
11.11.3 Printer Set.....	53



- 11.11.4 Clear Cache ..... 55
- 11.11.5 About..... 55
- 11.11.6 Diagnostic Software Auto Update ..... 56
- 11.11.7 Login/Exit from current account..... 56
- 11.12 Diagnostic Software Clear ..... 56
- 12 Others ..... 57**
- 12.1 Remote Diagnose..... 57
  - 12.1.1 Interface Layout..... 57
  - 12.1.2 Add Friends ..... 57
  - 12.1.3 Start Instant Messaging..... 58
  - 12.1.4 Launch Remote Diagnosis (Device-To-Device)..... 59
  - 12.1.5 Launch Remote Diagnosis (Device-To-PC)..... 61
- 12.2 Toolbox ..... 62
- 12.3 Tablet Setting..... 62
- 12.4 Files ..... 62
- 12.5 Wireless Upgrade ..... 63
- 12.6 TeamViewer QS..... 64
- 12.7 Recording Master ..... 64
- 12.8 Browser ..... 64
- 12.9 Camera..... 64
- 12.10 Gallery ..... 65
- 12.11 Video Player ..... 65
- 12.12 E-Mail ..... 65
- 12.13 Calculator ..... 65
- 13 J2534 Reprogramming Using SmartLink C..... 66**
- 13.1 As a Local J2534 PassThru Device..... 66
- 13.2 As a Remote J2534 PassThru Device..... 66
- 14 FAQ ..... 68**
- 14.1 About X-431 PAD VII ..... 68
- 14.2 About SmartLink Diag..... 70
- 15 Glossary of Terms & Abbreviations ..... 72**

# 1 Introduction

## 1.1 Product Profile

X-431 PAD VII is an evolutionary smart solution for professional automotive diagnostics and maintenance. This Android OS-based, tablet-style scanner incorporates the best possible coverage of OE-level diagnostics with multitasking capable software. It inherits from LAUNCH's advanced diagnosing technology and is characterized by covering a wide range of vehicles, featuring powerful functions, and providing precise test result.

Using the powerful Octa-core 2GHz processor, 8G RAM, and a 13.3" IPS capacitive touch screen with a resolution of 1920 x 1080 dots, it delivers quick and complete diagnostic functionalities which technicians need to diagnose, research and repair vehicles in one solution.

It supports the following functions:

- **Intelligent Diagnose**

This module allows you to use the VIN information of the currently identified vehicle to access its data (including vehicle information, historical diagnostic records) from the cloud server to perform quick test, eliminating guesswork and step-by-step manual menu selection.

- **Local Diagnose**

Follow the on-screen prompts to start diagnostic session step by step. Diagnosis functions include: Read DTCs, Clear DTCs, Read Data Stream, Special Functions etc.

- **Reset**

All kinds of common maintenance and reset items including Oil Reset Service, Electronic Parking Brake Reset, Steering Angle Calibration, ABS Bleeding, TPMS (Tire Pressure Monitor System) Reset, Gear Learning, IMMO Service, Injector Coding, Battery Maintenance System, Diesel Particulate Filter (DPF) Regeneration, Electronic Throttle Position Reset, Gearbox Matching, AFS (Adaptive Front-lighting System) Reset, Sunroof Initialization, Suspension Calibration etc.

- **SmartLink Diag.**

A perfect and powerful remote diagnostics solution developed by LAUNCH. In this ecology system, if a technician or car owner (SmartLink C) does not have time to puzzle through a touch vehicle problem, he can seek a trusted second opinion or additional expertise on various vehicle issues from remote master technicians or repair shops (SmartLink B). SmartLink B enables the shop owner to greatly increase customer's retention and boost shop revenue by providing the professional technical assistance service.

- **TPMS**

Enables you to activate tire pressure information, program tire pressure sensor and perform the TPMS relearning functions etc. It needs to work with the X-431 TSGUN device (sold separately) to perform all kinds of various TPMS functions.

- **One-click Update**

Lets you update your diagnostic software online.

- **Feedback**

Enables you to submit the vehicle diagnostic software problems or app bugs to us for analysis and troubleshooting.

- **ADAS**

This function needs to be activated before normal use and only works with the LAUNCH-specific ADAS calibration tool (sold separately).

- **Mall**

Enables you to subscribe some extra software or service functions that are not integrated in the tool online.

- **Vehicle Coverage**

Checks which vehicle models are supported on this tool.

- **Remote Diagnose**

This helps repair shops or mechanics to diagnose a remote vehicle, and launch instant messages,

allowing for improved efficiency and faster repairs.

- **Diagnostic History**





This function provides a quick access to the tested vehicles and users can choose to view the test report or resume from the last operation, without starting from scratch.

- **Add-on Modules**







Oscilloscope, Ignition, Sensor, Multimeter and Videoscope (sold separately) are available as add-on modules of the X-431 PAD VII.

## 1.2 Accessory Checklist

Common accessories are same, but for different destinations, the accessories (such as diagnostic software, testing connectors) may vary. Please consult from the local agency or check the package list supplied with this tool together.

No.	Name	Qt.	Picture & Notes
1	Display Tablet	1	
2	SmartLink C Device	1	
3	Diagnostic Cable	1	 (Connects the SmartLink C device to the OBD II vehicle's DLC.)
4	Data Cable (Type A- Type B)	1	 (Connects the SmartLink C device to PC for J2534 reprogramming.)
5	Data Cable (Type A- Type C)	1	 (Connects the tablet to PC for data exchange.)
6	Crossover Cable	1	 (Connects the SmartLink C device to the modem while performing SmartLink diagnostics.)



7	<b>Power Adaptor</b>	1	 <p>(For charging the tablet.)</p>
8	<b>Password Envelope</b>	1	 <p>(A piece of paper bearing Product S/N and Activation Code, which is required for your registration.)</p>
9	<b>Cigarette Lighter Cable</b>	1	 <p>(To provide power to the non-16pin connector through connection to the Cigarette Lighter receptacle.)</p>
10	<b>Battery Clamps Cable</b>	1	 <p>(To provide power to the non-16pin connector through connection to the vehicle's battery.)</p>
11	<b>OBD I Adaptor</b>	1	 <p>(A adaptor cable for connecting non-16 pin dongle.)</p>
12	<b>Mini High Definition Media Interface Cable</b>	1	 <p>(To mirror the tablet screen onto an external projector or monitor with HD interface.)</p>
13	<b>Non-16pin Connector Kit</b>		(Optional)

## 2 Components & Controls

There are two main components to the diagnostic system:

- Display Tablet -- the central processor and monitor for the system (For details, please refer to Chapter 2.1.)



- SmartLink C Device -- the device for accessing vehicle data (For details, please refer to Chapter 2.2.)



### 2.1 Display Tablet

The tablet acts as the central processing system, which is used to receive and analyze the live vehicle data from the SmartLink C device and then output the test result.

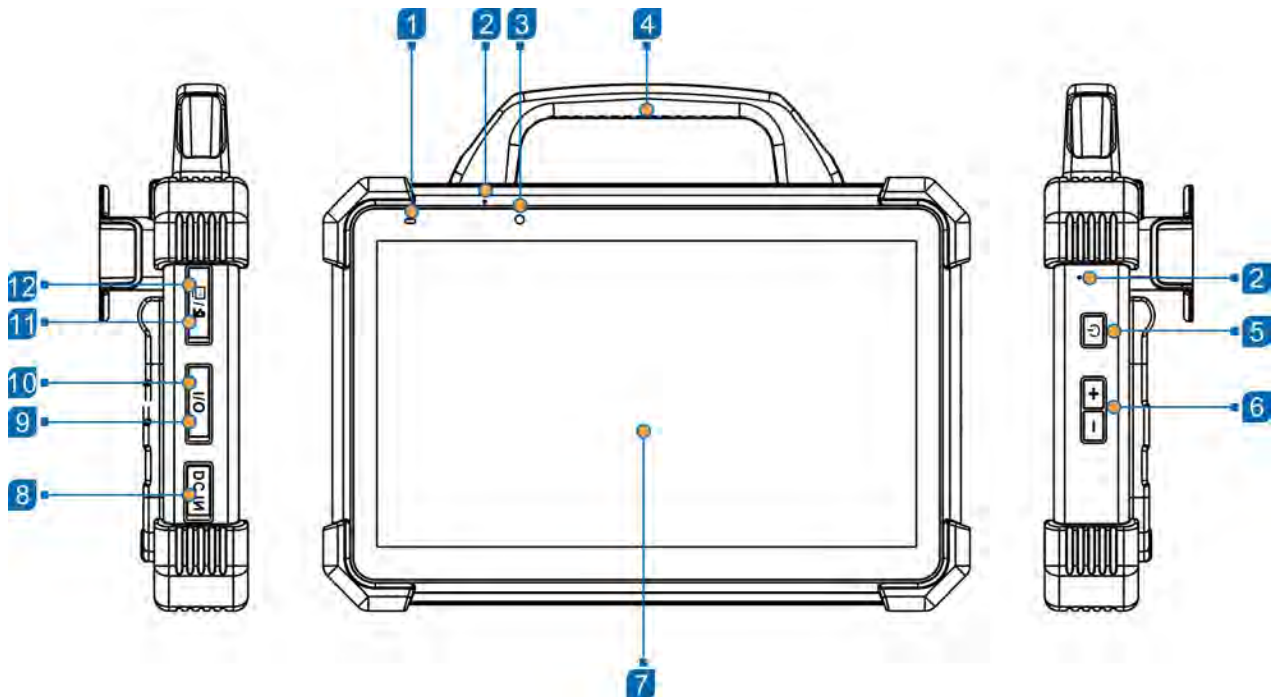

The following table formulates ports and indicators of display tablet:

No.	Name & Descriptions
1	<b>Charging indicator</b> -- It illuminates red while the tablet is charging. Once charging is finished, it will illuminate solid green.
2	<b>Microphone</b>
3	<b>Front Camera</b>
4	<b>Handgrip</b>
5	<b>Power/Screen Lock Button</b> -- To turn the tablet on/off with long press, or lock the screen with short press.
6	<b>Volume Buttons</b> -- To adjust the volume.  Note: Press and hold [POWER] and [VOL -] key to capture the current screenshot.
7	<b>Display Screen</b>
8	<b>DC IN Port</b> -- Connects the power adaptor to charge the tablet.
9	<b>Type-C Data Transmission Port</b> -- Connects it to the PC for data exchange.
10	<b>Type-A Port</b> -- Reserved for add-on modules (such as Oscilloscope, Ignition, Sensor, Multimeter etc), and other devices with similar port.
11	<b>Memory Card Slot</b> -- Stores the memory card for storage expansion. <b>SIM Card Slot</b> -- Disabled for this edition.
12	<b>High Definition Multimedia Output Port</b> -- Connects it to an external projector or monitor with similar interface.

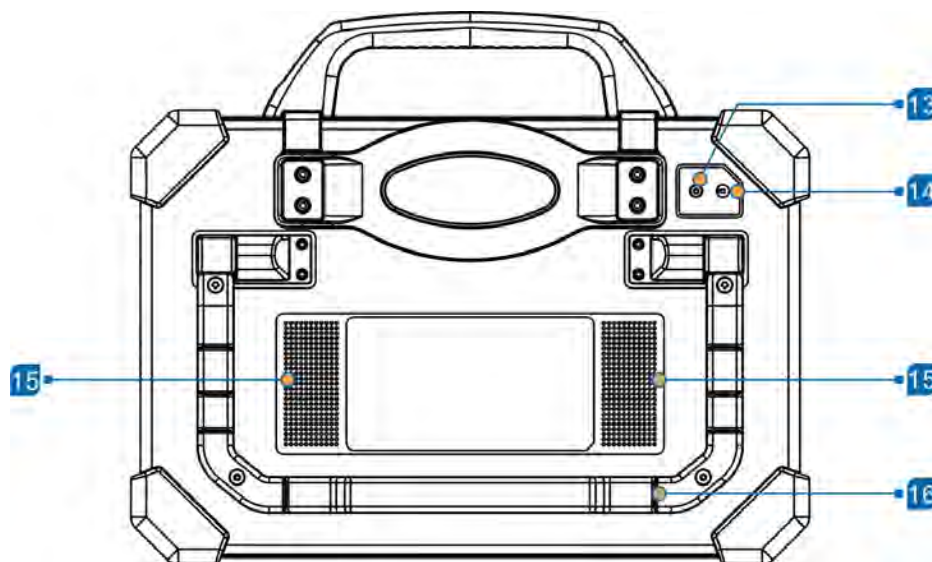

No.	Name & Descriptions
13	<b>Rear Camera</b>
14	<b>Camera Flash</b>

15	<b>Audio Speaker</b>
16	<b>Adjustable Kickstand</b> - Flip out it to any angle and work comfortable at your desk, or hang it on automotive part.

## 2.2 SmartLink C Device

The SmartLink C device features powerful functions and it can be applied in the following situations:

1. When as a **VCI (Vehicle Communication Interface)**, it needs to work in conjunction with the Diagnose module of the tablet, which is used to obtain vehicle data, and then send it to the tablet for analysis via WiFi/Bluetooth.
2. When as a **SmartLink C (Customer) dongle**, it does not communicate with the tablet, but it needs to work together with the SmartLink module of the tablet. The tablet is mainly used to issue remote diagnostic requests, and the SmartLink C dongle is networked to receive and execute commands from the remote SmartLink B (Business).

 Note: For detailed operations, please refer to Chapter 8.

3. When as a **local or remote J2534 PassThru device**, it can be used in conjunction with the PC installed with OEM diagnostic software.

 Note: For detailed operations, please refer to Chapter 13.

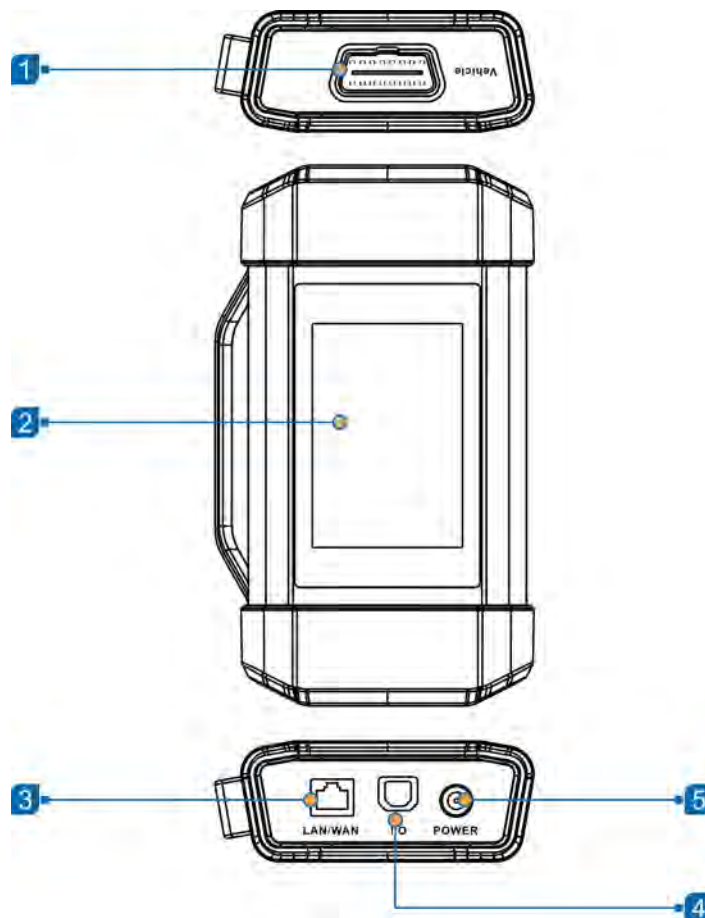

No.	Name & Descriptions
1	<b>OBD-16 Diagnostic Connector</b> -- Connects the SmartLink C device to the vehicle's DLC (Data Link Connector) port via the OBD II extension cable.

2	<b>Display Screen</b>
3	<b>LAN/WAN Port</b> -- Connects the SmartLink C device to the Internet via the crossover cable.
4	<b>Data I/O Port</b> -- Connects the SmartLink C device to the PC via the data cable when as a J2534 PassThru device.
5	<b>DC-IN Port</b> -- Currently disabled and for manufacturer use only.  <b>Warning: The SmartLink C device obtains power through the vehicle's DLC, and it is prohibited to connect to an external DC power supply. No responsibility can be assumed for any damage or loss caused as a result of not strictly following the above method.</b>

## 2.3 Technical Specifications

### A. Display Tablet

Item	Description
<b>Operating system</b>	Android 9
<b>CPU</b>	Octa-core processor, 2GHz
<b>Display</b>	13.3 inch IPS capacitive touch screen with 1920 x 1080 resolution
<b>Memory</b>	8GB
<b>Hard disk</b>	256GB
<b>Connectivity</b>	<ul style="list-style-type: none"> <li>• Wi-Fi: 2.4G/5GHz dual frequency</li> <li>• Universal serial BUS ports (1 x Type-C + 1 x Type-A)</li> </ul>
<b>Camera</b>	13MP rear-facing camera (Auto focus)
<b>HDMI</b>	MicroHDMI out
<b>Speaker</b>	Two 1.5W speakers
<b>Microphone</b>	Two microphones
<b>Operating Temperature</b>	-10°C ~ 50°C (14 ~122°F)
<b>Storage Temperature</b>	-20°C ~ 70°C (-4 ~158°F)

### B. SmartLink C Device



Item	Description
<b>Working voltage</b>	DC 9V ~ 36V
<b>Size</b>	204mm x 110mm x 45mm
<b>Typical power consumption</b>	≤ 6W
<b>Communication via</b>	Bluetooth, Wi-Fi or data cable connection
<b>Operating Temperature</b>	-10°C ~ 50°C (14 ~122°F)

## 3 Preparations

### 3.1 Charging the Tablet

#### Warnings:

- Only use the included power adaptor to recharge the tablet. Use of any other adaptor will damage the tool. We assume no responsibility for damage or loss resulting from using other similar adaptors other than the specified one.
- Always charge on a non-flammable surface in a well-ventilated area.

1. To check the battery power level, press and hold the Power button about 3 seconds to turn on the tablet.
2. Power level is indicated as a percentage in the upper right corner of the screen. If the power level drops below 10% while the tablet is on, a **Connect Charger** notification will appear on the screen.
1. Connect one end of the power adaptor to Type C charging port of the tablet, and the other end to the AC outlet.
2. The charging LED illuminates solid red and the charging symbol  will appear on the screen.
3. Once it illuminates solid green, it indicates that the battery is fully charged and the charging complete symbol  replaces the charging symbol. Disconnect the power adaptor from the AC outlet.

### 3.2 Power ON/OFF





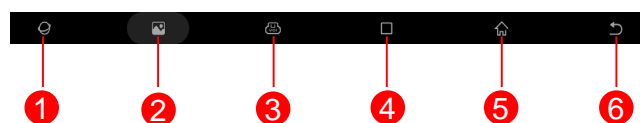

 Note: If it is the first time you use the tablet or the tablet keeps idle for a long time, it could fail to be turned on. It results from low battery. In this case, please recharge it for a while and try to turn it on.

1. Press and hold the POWER button for about 3 seconds to turn on the tablet. The system starts initializing and then enters the Home screen.
2. To turn the tablet off, press and hold the POWER button until an option menu appears. Tap **Power Off**.

### 3.3 Locator & Navigation Buttons



On-screen keys and status bar are as follows:

- |   |  |
|---|--|
| 1 | Tap  to visit the Launch's official website.  |
| 2 | Tap  to capture the current screen and all captured screenshots are stored in the Screenshots folder.   |
| 3 |  : Shows whether the SmartLink C device is properly connected or not.   |
| 4 | Tap  to display a list of applications that are currently running or recently used. To open an application, tap it. To remove an application, swipe it upwards. |
| 5 | Tap  to navigate to the Android System's home screen.   |
| 6 | Tap  to return to the previous screen or exit the application.  |

### 3.4 Wi-Fi Setup

The tablet has dual built-in Wi-Fi communication modules. One is used to communicate with the tablet, and the other allows the tablet to get online. Once you're online, you can register your tool, update diagnostic software & APK, browse the Internet and send email on your network.

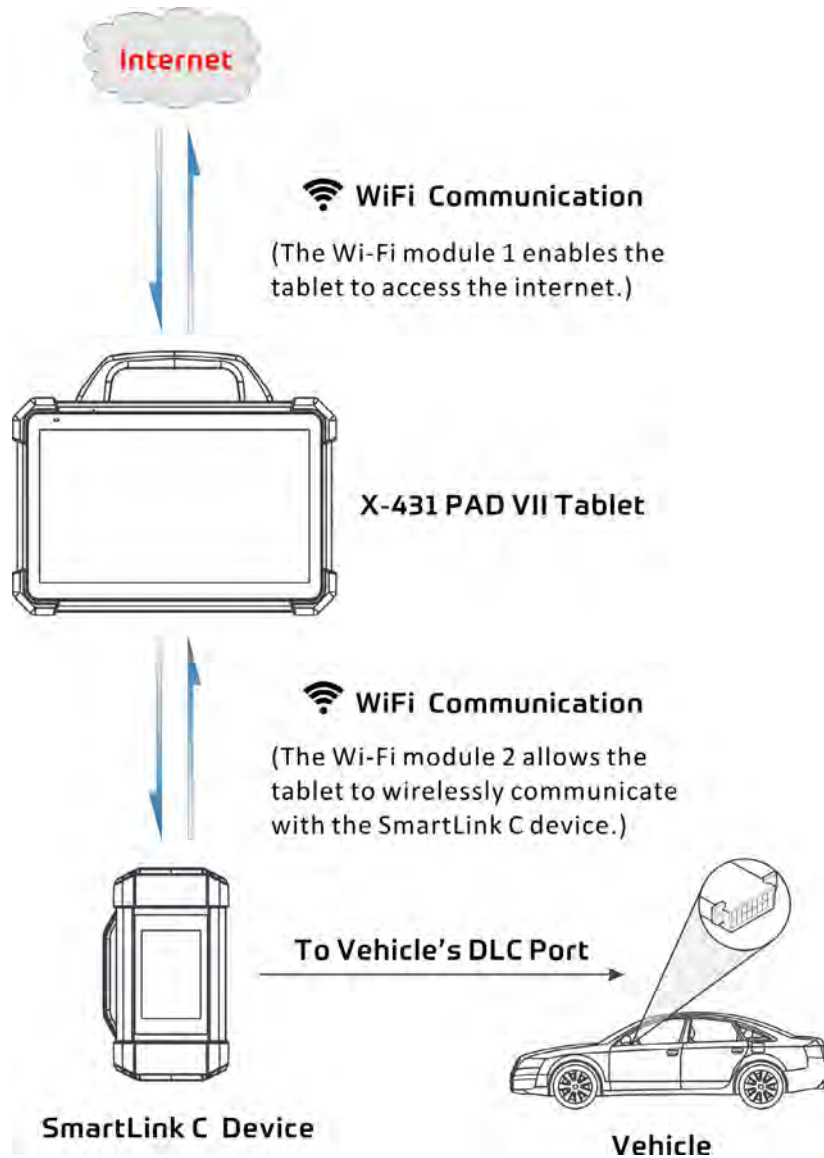

If the SmartLink C device is successfully activated, it will be automatically bound to the tablet. In this case it is not necessary for the user to manually configure it again.

**Note:** Once WLAN is set as ON, the tablet will consume more power. While it keeps unused, please set it off to save power. While WLAN is not in use, please turn it off to conserve battery power.

#### Connect to a WLAN Network

1. On the Home screen, tap **Settings -> Network & internet -> Wi-Fi**.
2. Slide the Wi-Fi switch to ON, the tablet starts searching for available wireless LANs.
3. Select the desired WLAN network from the list. If the chosen network is open, you can connect directly. A password may be required for secured networks.



## Disconnect from a WLAN Network

1. On the Home screen, tap **Settings -> Network & internet -> Wi-Fi**.
2. Tap the network with a **Connected** status, then tap **Forget**.

## 3.5 Adjust Brightness

---

 Note: Reducing the brightness of the screen is helpful to conserve the battery power.

1. On the home screen, tap **Settings -> Display -> Brightness level**.
2. Drag the slider to adjust it.

## 3.6 Change System Language

---

The tool supports multiple system languages. To change the language of the tool, please do the following:

1. On the home screen, tap **Settings -> System -> Language & input -> Languages**.
2. Tap **Add a language**, and then choose the desired language from the list.
3. Tap and hold the desired language and drag it to the top of the screen and then release it, the system will change into the target language.

## 3.7 Set Standby Time

---

If no activities are made within the defined standby period, the screen will be locked automatically and the system enters sleep mode to save power.

1. On the home screen, tap **Settings -> Display -> Advanced -> Sleep**.
2. Choose the desired sleep time.



## 4 Initial Use

### 4.1 Register & Download Diagnostic Software

For new users, please follow the operation chart shown below to get started with this tool.

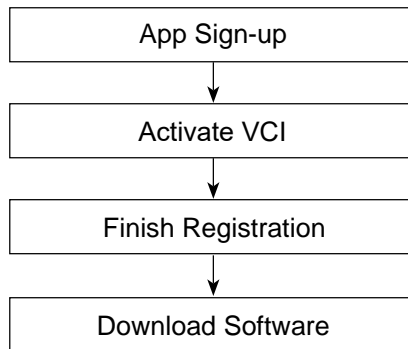

Note: Before registering, please make sure that the tablet has a strong and stable Wi-Fi signal.

On the home screen, tap the application icon to launch it, and then tap **Login** on the upper right corner of the screen. The following dialog box will pop up on the screen.

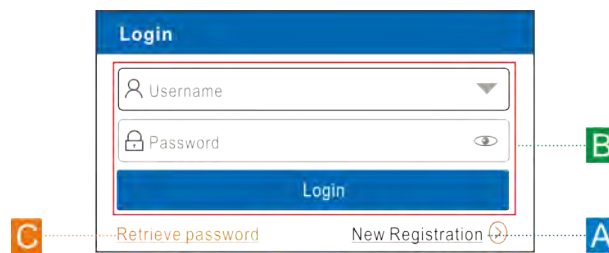

(If you are a new user, follow **A** to proceed.)

(If you have registered to be a member, go to **B** to login the system directly.)

(In case you forgot the login password, refer to **C** to reset a new password.)

A. If you are a new user, tap **New Registration** to enter registration page.

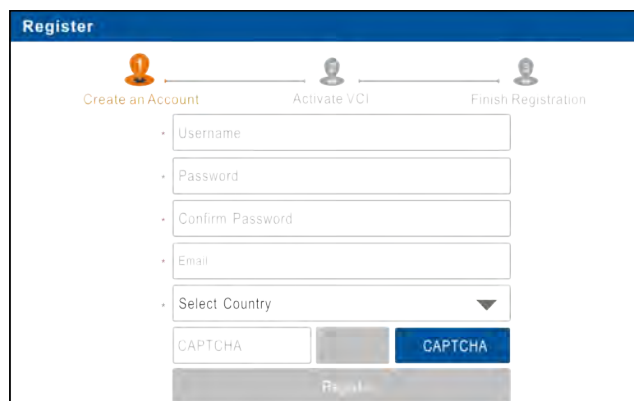

Fill in the information in each field (Items with \* must be filled). After inputting, tap **Register**, the following screen will appear:

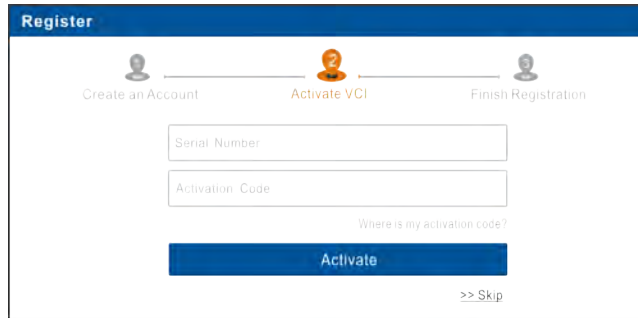

Input the Serial Number and Activation Code, which can be found in the Password Envelope.



**Note:** To exit and activate it later, tap **Skip**. In this case, you can activate it by tapping **User Info -> Activate VCI**.

Tap **Activate** to finish your registration.

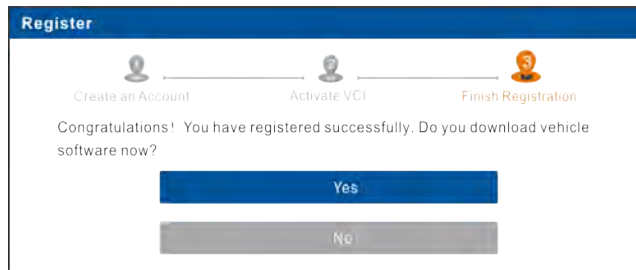

To download the diagnostic software, tap **Yes** to enter the download page. Tap **No** to download and install it later.

On the download page, tap **Update** to start downloading. To pause downloading, tap **Stop**. To resume it, tap **Continue**. Once download is complete, the system will install the software package automatically.

**Notes:**

- In process of download, please make sure the tablet has a strong Wi-Fi signal. It may take several minutes to finish it, please be patient to wait.
- To use the AutoDetect (VINScan) function, you have to download the corresponding diagnostic software and AutoSearch file.

B. If you have registered to be a member, input your name and password, and then tap **Login** to enter the main menu screen directly.

**Note:** The tablet has an auto-save function. Once the username and password are correctly entered, the system will automatically store it. Next time you login the system, you will not be asked to input the account manually.

C. If you forgot the password, tap **Retrieve password** and then follow on-screen instructions to set a new password.

## 4.2 Job Menu

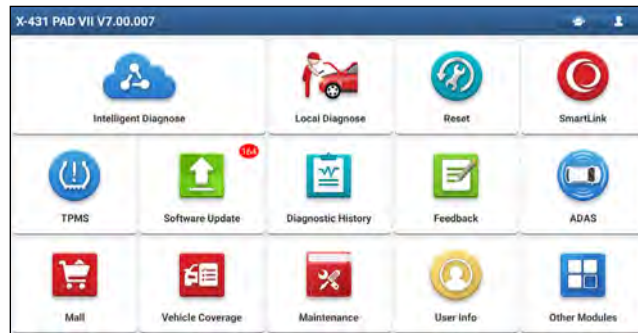

It mainly includes the following items:

<b>Intelligent Diagnose</b>	This module allows you to obtain vehicle data from the cloud server to perform quick test via reading VIN, which provides a perfect solution to various defects resulting from step-by-step menu selection. In addition, user can also check the historical repair records online through this module.
<b>Local Diagnose</b>	To diagnose a vehicle manually.
<b>Reset</b>	To perform all kinds of common repair & maintenance items, including Oil Reset Service, Electronic Parking Brake Reset, Steering Angle Calibration, ABS Bleeding, TPMS (Tire Pressure Monitor System) Reset, Gear Learning, IMMO Service, Injector Coding, Battery Maintenance System, Diesel Particulate Filter (DPF) Regeneration, Electronic Throttle Position Reset, Gearbox Matching, AFS (Adaptive Front-lighting System) Reset, Sunroof Initialization, Suspension Calibration etc.
<b>SmartLink</b>	<p>The SmartLink system is powerful remote diagnostics solution developed by LAUNCH.</p> <p>The system consists of SmartLink C dongle, SmartLink Service Platform and SmartLink B dongle.</p> <ul style="list-style-type: none"> <li>✔ <b>SmartLink C dongle:</b> For technicians seeking technical assistance and additional expertise on various vehicle issues.</li> <li>✔ <b>SmartLink Service Platform:</b> For SmartLink C posting assistance request and SmartLink B accepting order.</li> <li>✔ <b>SmartLink B dongle:</b> For service provider or master technician providing technical assistance service.</li> </ul>
<b>TPMS</b>	Configures this tool as a professional TPMS (Tire Pressure Monitoring System) service tool. It provides the ability to activate tire pressure information, program tire pressure sensor and perform the TPMS relearning functions etc. It needs to work with the X-431 TSGUN device (sold separately) to perform all kinds of various TPMS functions.
<b>Software Update</b>	To update vehicle diagnostic software and APK.
<b>Diagnostic History</b>	Generally once a vehicle diagnosis is performed, the tablet will record the every details of diagnostic process. The History function provides a quick access to the tested vehicles and users can resume from the last operation, without starting from scratch.
<b>Feedback</b>	To feed back the recent 20 diagnostic logs to us for issue analysis.

<b>ADAS</b>	This function enables users to perform ADAS (Advanced Driver Assistance System) calibration operations. The ADAS calibration software is disabled by default. Before using this function, users must activate the ADAS function using the ADAS Activation Card.  Note: This function requires the diagnostic tool to work with the specific ADAS calibration tool(calibration tools from other manufacturers will not be supported).
<b>Mall</b>	This module enables you to subscribe some extra software or service functions that are not integrated in the diagnostic tool online.
<b>Vehicle Coverage</b>	To check the vehicle models supported on the tablet.
<b>Maintenance</b>	Abundant maintenance data are available, which helps repair professionals diagnose and repair vehicles efficiently, accurately and profitably.
<b>User Info</b>	To manage VCI, diagnostic reports & records, change password, configure Wi-Fi printer, data stream sample and logout / login etc.
<b>Other Modules</b>	Includes Toolbox (add-on modules, such as Oscilloscope, Ignition, Sensor, Multimeter, Battery), Product Manual, FAQ and some system Apps etc.

## 4.3 Connections

### 4.3.1 Preparation

#### Normal testing conditions

- Turn on the vehicle power supply.
- Vehicle battery voltage range should be 9-18V or 11-36V and working voltage of the tablet is 5V.
- Throttle should be closed at its close position.

#### Select testing connectors/adaptor cables

If the tablet is testing vehicles equipped with universal OBD II (16 pin) diagnostic socket, please use the included SmartLink C device. For vehicles with non-OBD II (non-16 pin) diagnostic socket, a non-16 pin connector is required.

### 4.3.2 DLC Location

For Passenger Vehicles, the DLC (Data Link Connector or Diagnostic Link Connector) is the standardized 16-cavity connector where diagnostic code readers interface with the vehicle's on-board computer. The DLC is usually located 12 inches from the center of the instrument panel (dash), under or around the driver's side for most vehicles. If Data Link Connector is not located under dashboard, a label should be there telling location. For some Asian and European vehicles, the DLC is located behind the ashtray and the ashtray must be removed to access the connector. If the DLC cannot be found, refer to the vehicle's service manual for the location.

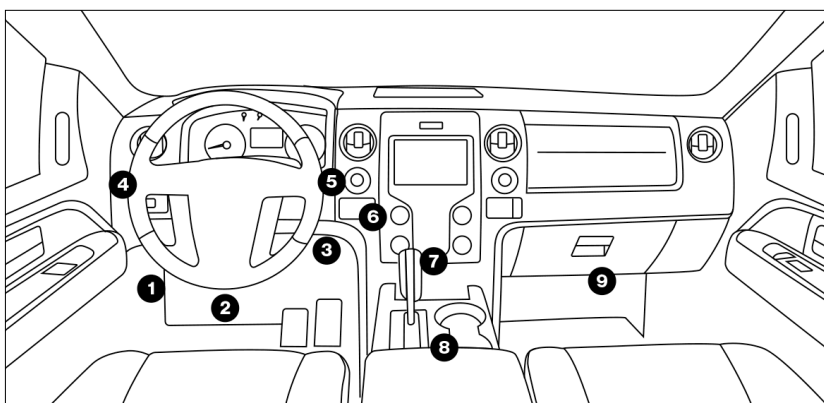

### 4.3.3 Vehicle Connection

The method used to connect the SmartLink C device to a vehicle's DLC depends on the vehicle's configuration as follows:

- A vehicle equipped with an OBD II management system supplies both communication and 12V power through a standardized DLC.
- A vehicle not equipped with an OBD II management system supplies communication through a DLC connection, and in some cases supplies 12V power through the cigarette lighter receptacle or a connection to the vehicle battery.

For OBD II vehicles, connect the SmartLink C to vehicle's DLC port directly via the OBD II extension cable.

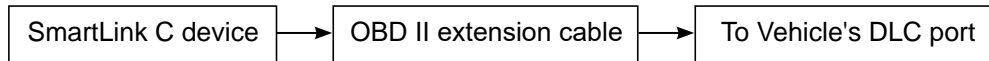

For non-OBDII vehicle, proceed as follows:

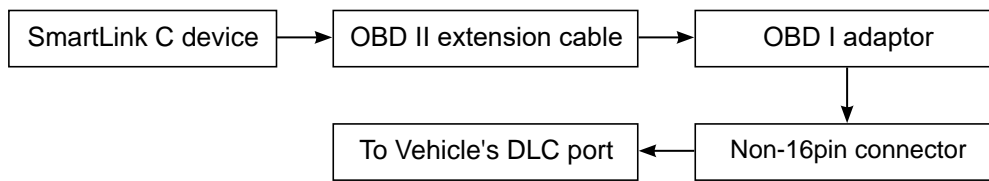

#### Notes:

If the power supply on vehicle diagnostic socket is insufficient or the power pin is damaged, you can get power via either of the following ways:

- A. Via Battery clamps cable (optional): Connect one end of the battery clamps cable to the power jack of the OBD I adaptor box, and the other end to the vehicle's battery.

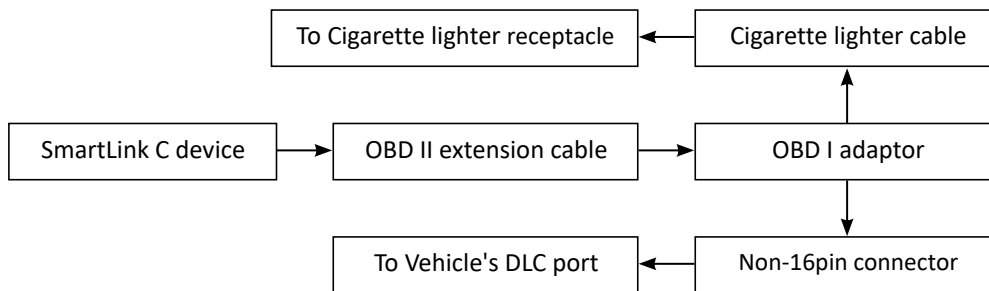

- B. Via Cigarette lighter cable (optional): Connect one end of the cigarette lighter cable to the power jack of the OBD I adaptor box, and the other end to the cigarette lighter receptacle.

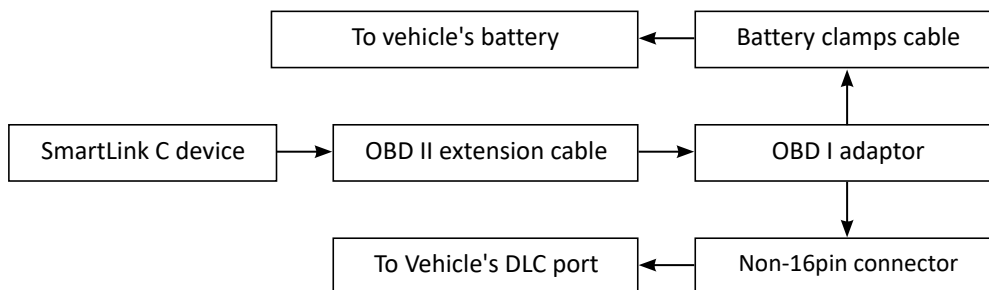

### 4.4 Communication Setup

There are 3 kinds of ways available for the tablet to communicate with the SmartLink C device: Wi-Fi, Bluetooth and USB cable.

After the sign-up is successfully completed, the Wi-Fi communication between the tablet and the SmartLink C device is automatically established and user has no need to configure it again.

The Bluetooth communication is inferior to the Wi-Fi communication in transmission speed and stability.

This method is not recommended.

The USB cable connection is a simple & quick way to establish communication between the tablet and the SmartLink C device.

After properly connecting the SmartLink C device to the tablet, the VCI  navigation button at the bottom of the screen becomes highlighted indicating the communication is established.



Note: The USB connection provides the most stable and fastest communication. When all communication methods are applied at the same time, the tablet will use the USB communication as the default priority.

## 5 Start Diagnostics

### 5.1 Intelligent Diagnose

Through simple Wi-Fi communication between the tablet and SmartLink C device, you can easily get the VIN (Vehicle Identification Number) information of the currently identified vehicle. Once the VIN is successfully identified, the system will retrieve it from the remote server and then guide you to vehicle information page without the necessity of step-by-step manual menu selection.

The vehicle information page lists all historical diagnostic records of the vehicle, which lets the technician have a total command of the vehicle faults. In addition, a quick dial to local diagnosis and diagnostic function are also available on this page for reducing the roundabout time and increasing productivity.

#### Notes:

- Before using this function, please make sure the SmartLink C device is properly connected to the vehicle's DLC. For detailed connection, see Chapter 4.3.3 Vehicle Connection.
- A stable network connection is required for this function.

Follow the steps below to proceed.

1. Tap **Intelligent Diagnose** on the Job Menu.



 Note: If the system detects a newer firmware version, it will automatically update it and the following screen will appear:



After the firmware update is finished, tap **OK** to start reading VIN.

2. After pairing is complete, the tablet starts reading the vehicle VIN.
  - A. If the VIN can be found from the remote server database, the following screen will appear:



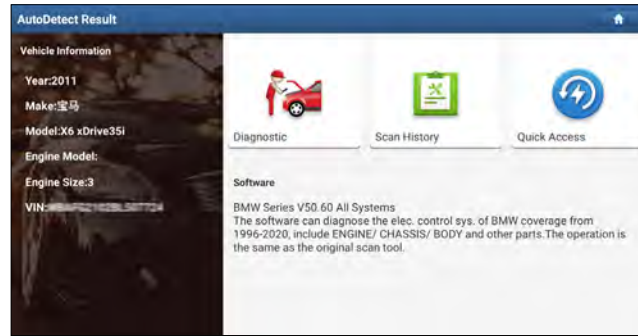

- Tap **Diagnostic** to start a new diagnostic session.





- Tap **Scan History** to view its historical repair record. If there are records available, it will be listed on the screen in sequence of date. If no records exist, the screen will show **No Record**.

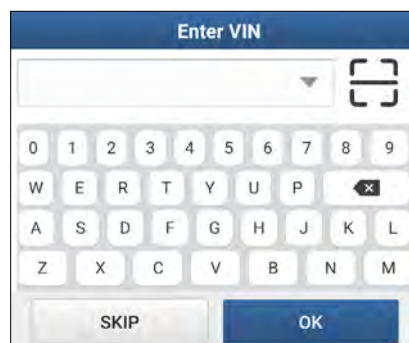

- Tap **View record** to view the details of the current diagnostic report.
- To perform other functions, tap **Quick access** to directly go to the function selection screen. Choose the desired one to start a new diagnostic session.

B. If the tablet failed to access the VIN information, the following dialog box will appear on the screen.







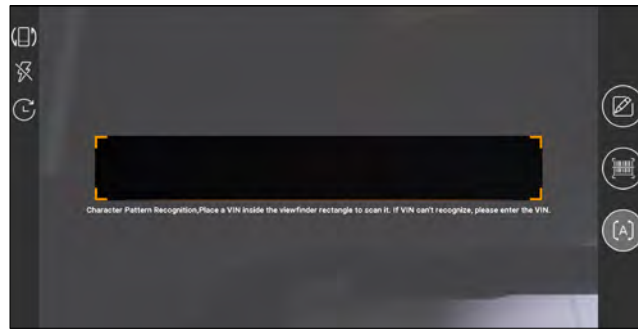

In this mode, you need to input the VIN manually or tap  to scan it.

- 1) Tap  to launch the VIN recognition module.







Place the VIN inside the viewfinder rectangle to scan it. The most recognizable location for this number is in the top left corner on the vehicle’s dashboard. Other locations include the driver’s door or post, and the firewall under the hood.

- To switch the display orientation, tap .
- To turn the flash on, tap .
- If you have scanned the VIN of the vehicle, tap  to choose it from the record list.
- In case the tablet failed to detect it, tap  to enter it manually.
- Tap  to switch the camera to barcode pattern recognition mode.
-  indicates the camera is in character pattern recognition mode (default mode).

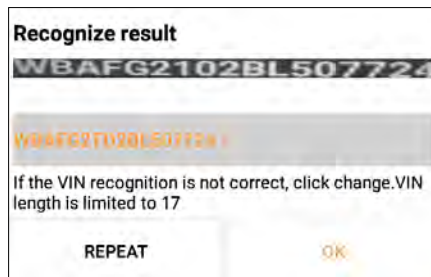
After scanning, the screen automatically displays the result.



- If the VIN scanned is incorrect, tap the result field to modify it and then tap **OK**. If the VIN exists on the remote server, the system will enter the vehicle information screen.
  - To scan it again, tap **REPEAT**.
- 2) Input the VIN, and tap **OK**, the system will automatically identify the vehicle model and directly navigate to the vehicle information page.



 Note: In general, vehicle identification numbers are standardized - all contain 17 characters. VIN characters may be capital letters A through Z and numbers 1 through 0; however, the letters I, O and Q are never used in order to avoid mistakes of misreading. No signs or spaces are allowed in the VIN.

## 5.2 Local Diagnose

Tap **Local Diagnose** to enter the vehicle selection page.

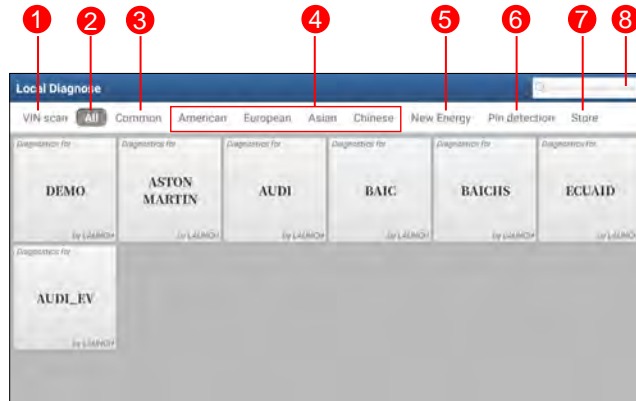
### 5.2.1 Main Menu



1	<p>VINScan button: Tap it to scan the Vehicle Identification Number (VIN) code of your vehicle. OBD VIN and INPUT VIN are included. This function does not apply to the commercial vehicles.</p> <p> Note: Before using this function, the corresponding diagnostic software and Auto search file need to be downloaded on your tool first while downloading the diagnostic software.</p>
2	All Tab: Displays all the vehicle makes.
3	Common Tab: Displays all frequently-used vehicle makes.
4	Regional buttons: Tap different buttons to switch to corresponding vehicles.
5	New Energy: Displays all new energy vehicle makes.
6	<p>Pin Detection: This module allows you to detect the voltage of the vehicle OBD II diagnostic socket pins and the supported protocol types to help technicians judge the OBD II diagnostic interface.</p> <p> Note: Before using this function, the SmartLink C device should be properly connected to the vehicle's DLC port.</p>  <p>The screenshot shows the 'Pin detection' interface. It displays a grid of voltage readings for OBD II pins. The readings are: 0.0V, 0.0V, 0.0V, 0.0V, 2.2V, 0.0V, 0.0V, 0.0V, 0.0V, 0.0V, 2.2V, 13.4V, and 14.0V. A 'Check result' button is visible, and the OBD ID is shown as 'OBD 6#14#'. Below the readings, it says 'DIAGNOSIS COMPLETED, RE-DIAGNOSE'.</p> <p>Analysis and description: Pin detection can be used to detect the voltage of the vehicle OBD-II diagnostic socket pins and the supported protocol types to help technicians judge the OBD-II diagnostic interface. If the detection result does not match the actual vehicle configuration, the corresponding pin may</p>
7	Store: Allows you to renew the subscription of diagnostic software and check the order status.
8	Search bar: Enables you to quickly locate the desired vehicle make.

2 approaches are provided for you to access the vehicle diagnostic software.

## 5.2.2 VINSCAN

This function enables you to access it more quickly.

In this case, camera scan and manual input are available.

Tap **VIN scan**, the screen displays as follows:





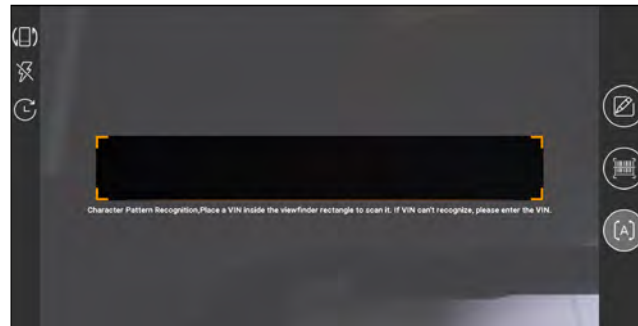

**A. Camera Scan:** In this mode, the SmartLink C device should be plugged into the vehicle's DLC.

Tap **Camera Scan**, the following screen will appear:



Place the VIN inside the viewfinder rectangle to scan it. The most recognizable location for this number is in the top left corner on the vehicle's dashboard. Other locations include the driver's door or post, and the firewall under the hood.

- To switch the display orientation, tap .
- To turn the flash on, tap .
- If you have scanned the VIN of the vehicle, tap  to choose it from the record list.
- In case the tablet failed to detect it, tap  to enter it manually.
- Tap  to switch the camera to barcode pattern recognition mode.
- **[A]** indicates the camera is in character pattern recognition mode (default mode).

Once the test vehicle is successfully identified, the tablet will navigate to the function selection page directly.

Tap the desired option to perform the corresponding function.



**Note:** Before using this function, the corresponding diagnostic software and Auto search file need to be downloaded on your tool first while downloading the diagnostic software.

**B. Enter VIN:** In this mode, you need to input the VIN manually. In general, vehicle identification numbers are standardized - all contain 17 characters. VIN characters may be capital letters A through Z and numbers 1 through 0; however, the letters I, O and Q are never used in order to avoid mistakes of misreading. No signs or spaces are allowed in the VIN.

Tap **Enter VIN**, the following screen will appear:



Input the VIN, and tap **OK**, the system will automatically identify the vehicle model and directly navigate to the function selection page.

### 5.2.3 Manual Selection

Tap a corresponding diagnostic software logo, and then follow the on-screen instruction to access the diagnostic software.

Take Demo as an example to demonstrate how to diagnose a vehicle.

1). Select diagnostic software version: Tap **DEMO** to go to Step 2.

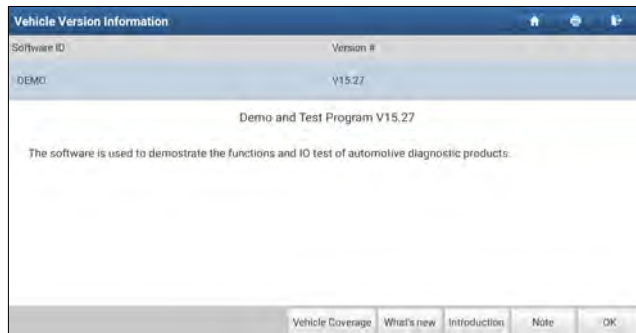

The diagnostics toolbar contains a number of buttons that allow you to print the displayed data or make other controls. It is displayed on the upper right corner of the screen and goes through the whole diagnostic session. The table below provides a brief description for the operations of the diagnostics toolbar buttons:

<b>Home</b>	Tap to navigate to the home screen.
<b>Print</b>	Touch to print the selected screenshots out via external printer. The printer needs to be configured separately. For details on printer setting, see Chapter 11.11.3 Printer Set.
<b>Exit Session</b>	Tap to exit the current diagnostic session.

On-screen Buttons:

Vehicle Coverage: Tap to view the vehicle models that the current diagnostic software covers.

What's new: Tap to view the optimized items and enhancements.

Introduction: Tap to check the software function list.

Note: Tap to read some precautions on using the current diagnostic software.

OK: Tap it to go to next step.

2). Select vehicle model (varies with different versions): Select the desired vehicle model. Here we take Ford for example to demonstrate how to diagnose a vehicle.

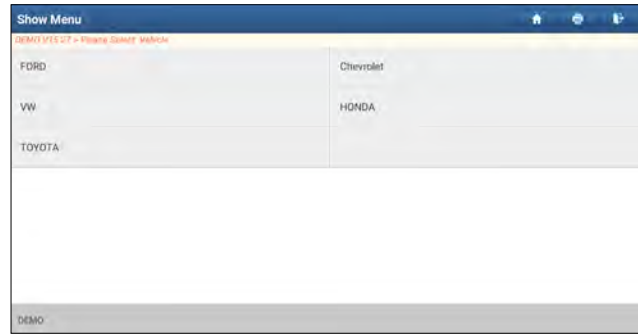

3). Turn the ignition key to ON: Set the ignition switch to on.

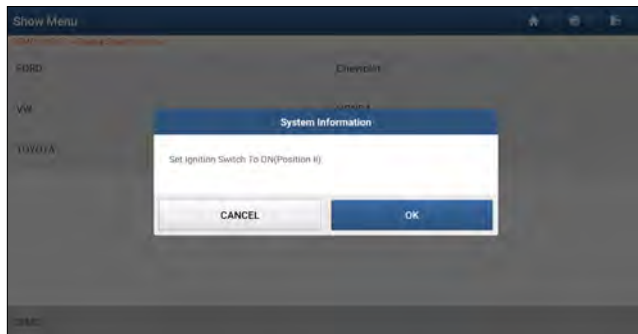

5). Read vehicle information: After reading the vehicle information, double check if the vehicle information is correct or not. If yes, tap **YES** to continue.

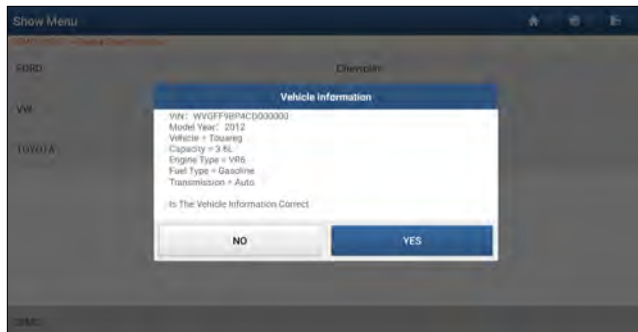

5). Select test item: Select the desired test item to proceed.

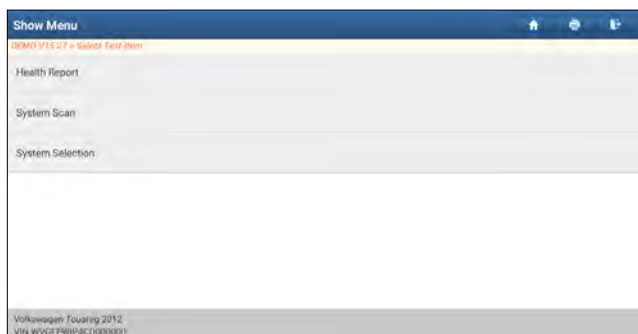

### 5.2.3.1 Health Report (Quick Test)

This function varies from vehicle to vehicle. It enables you to quickly access all the electronic control units of the vehicle and generate a detailed report about vehicle health.

Tap **Health Report** on the test item selection screen, the system starts scanning the ECUs. Once the scanning is complete, the following screen will appear:



The tested system with fault code appears in red and the system with OK displays in green (normally).

**Warning:** Diagnostic Trouble Codes or Fault Codes can be used to identify which engine systems or components that are malfunctioning. Never replace a part based only on the DTC definition. Retrieving and using DTCs for troubleshooting vehicle operation is only one part of an overall diagnostic strategy. Follow testing procedures (in vehicle’s service manual), instructions and flowcharts to confirm the locations of the problem.

**On-screen Buttons:**

∨: Tap to display the details of DTCs existing in the current system. Tap ^ to hide it.

Highlight certain DTC item, and tap to open the browser to retrieve it.

**Enter:** Tap to select other test functions.

**Report:** Tap to save the diagnostic result as a report.

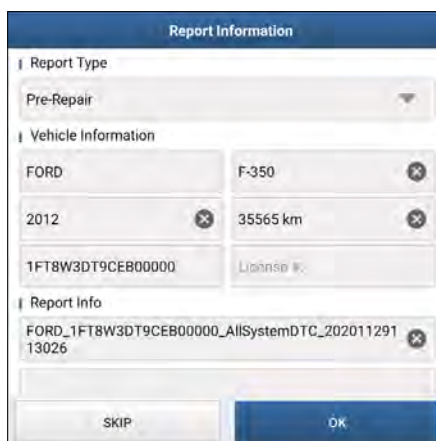

Tap ▼ to select the report type from the option list and input the required information, and then tap **OK**.

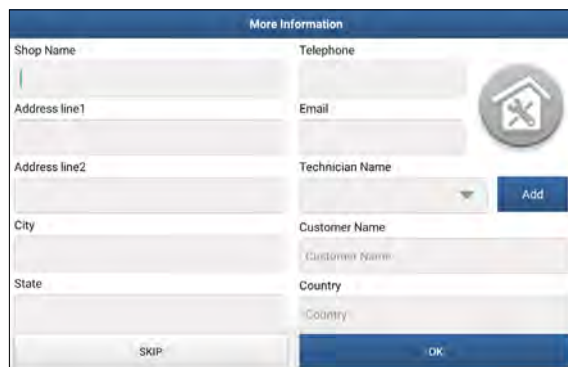

Enter the technician and customer name and then tap **OK** to confirm and navigate to the report details page. To ignore the workshop information, tap **Skip** to go to the report details page.

For workshop information, input it directly (alternatively you also can set it in **User Info -> Settings -> Print Information**). Once you configured the information, it will be automatically generated every time you saved the diagnostic report. All vehicle and workshop information will be appended as tags on the diagnostic

report.

 Note: Diagnostic report is classified into three categories: Pre-Repair report, Post-Repair report and Diagnostic Scan. No matter which type you saved the report as, the report type will be appended as a tag on the upper right corner of the diagnostic report for easier identification.

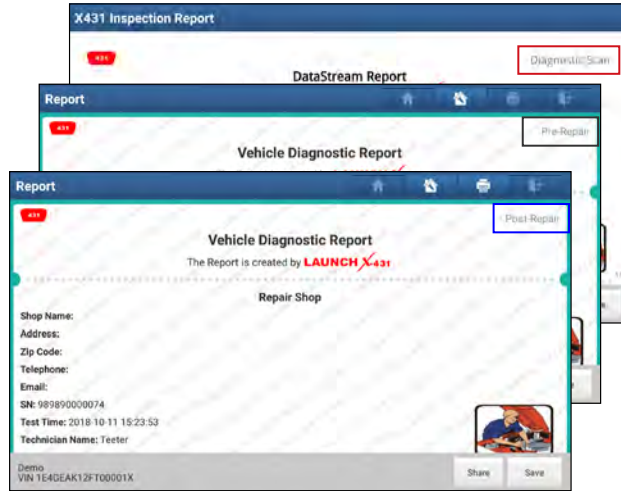

To facilitate the comparison of the pre-repair and post-repair reports and get accurate test result, please make sure you saved the right type of the diagnostic report.

To save the report as a common diagnostic report, select **Diagnostic Scan**.

On the report details page, tap **Save** to save it. All diagnostic reports can be accessed from **User Info -> My Reports -> Health Report**.

Help: Tap to view the help information of the selected DTC item.

Compare Results: Tap to select the pre-repair report to compare. By comparison of the pre- and post- repair reports, you can easily identify which DTCs are cleared and which remain unfixed.

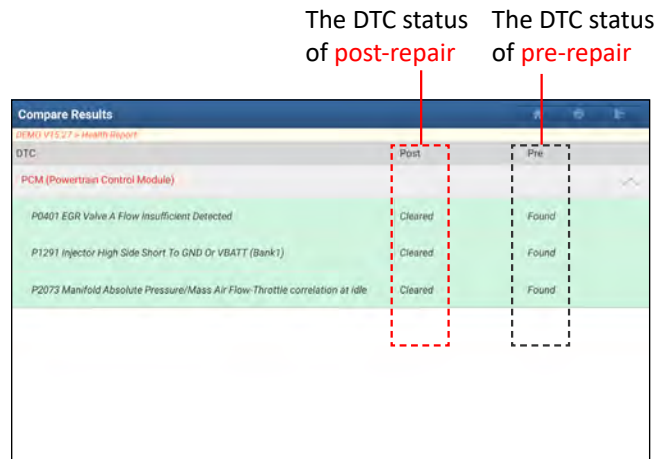

 Note: Before performing this function, please make sure that:

- You have saved a pre-repair report of the currently tested vehicle, and
- You have already made some repairs and service and cleared the DTCs after the pre-repair reported is generated. Otherwise, no differences exist between the pre- and post- repair reports.

Clear DTC: Tap to clear the existing diagnostic trouble codes.

 Note: Clearing DTCs does not fix the problem(s) that caused the code(s) to be set. If proper repairs to correct the problem that caused the code(s) to be set are not made, the code(s) will appear again and the check engine light will illuminate as soon as the problem that cause the DTC to set manifests itself.



### 5.2.3.2 System Scan

This option allows you to quickly scan which systems are installed on the vehicle.

Tap **System Scan** on the test item selection screen, the system starts scanning the systems. Once the scanning is complete, the screen will display the result.



Tap the desired system to advance to the test function selection page. For detailed operations on test function, please refer to Chapter 5.2.3.3 System Selection.

### 5.2.3.3 System Selection

This option allows you manually select the test system and function step by step.

Tap **System Selection** on the test item selection screen, the following screen will appear:



Swipe the screen from the bottom to view the vehicle system on the next page.

Tap the desired system (take **ECM** for example) to enter the test function selection screen.

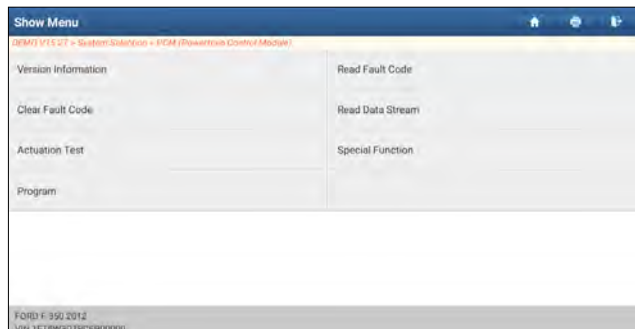

 Note: Different vehicle has different diagnostic menus.

#### A. Version Information

This function is used to read the version information of system mode, vehicle VIN, software and ECU.

#### B. Read Fault Code

This function displays the detailed information of DTC records retrieved from the vehicle's control system.

Tap **Read Fault Code** on the test function selection screen, the screen will display the diagnostic result.



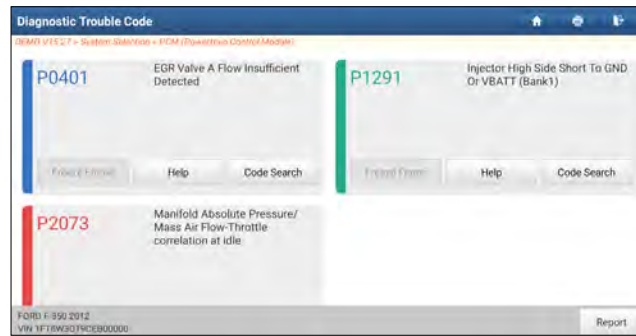

**Warning:** Retrieving and using DTCs for troubleshooting vehicle operation is only one part of an overall diagnostic strategy. Never replace a part based only on the DTC definition. Each DTC has a set of testing procedures, instructions and flow charts that must be followed to confirm the location of the problem. This information can be found in the vehicle's service manual.

#### On-screen Buttons:

**Freeze Frame:** When an emission-related fault occurs, certain vehicle conditions are recorded by the on-board computer. This information is referred to as freeze frame data. Freeze frame data includes a snapshot of critical parameter values at the time the DTC is set.

**Help:** Tap to view the help information.

**Code Search:** Tap it to search for more information about the current DTC online.

**Report:** To save the current data in text format. All diagnostic reports can be accessed from **User Info -> My Reports -> Diagnostic Report**.

#### C. Clear Fault Code

After reading the retrieved codes from the vehicle and certain repairs have been carried out, you can use this function to erase the codes from the vehicle. Before performing this function, please be sure the vehicle's ignition key is in the ON position with the engine off.

Clearing DTCs does not fix the problem(s) that caused the code(s) to be set. If proper repairs to correct the problem that caused the code(s) to be set are not made, the code(s) will appear again and the check engine light will illuminate as soon as the problem that cause the DTC to set manifests itself.

Tap **Clear Fault Code** on the test function selection screen, a confirmation dialog box pops up on the screen. Tap **Yes** and the system will automatically delete the currently existing trouble code.

**Note:** After clearing, you should retrieve trouble codes once more or turn ignition on and retrieve codes again. If there are still some trouble codes in the system, please troubleshoot the code using a factory diagnosis guide, then clear the code and recheck.

#### D. Read Data Stream

This option lets you view and capture (record) real-time Live Data. This data including current operating status for parameters and/or sensor information can provide insight on overall vehicle performance. It can also be used to guide vehicle repair.

**Danger:** If you must drive the vehicle in order to perform a troubleshooting procedure, always have a second person help you. Trying to drive and operate the diagnostic tool at the same time is dangerous, and could cause a serious traffic accident.

Tap **Read Data Stream** on the test function selection screen, the system will display data stream items.

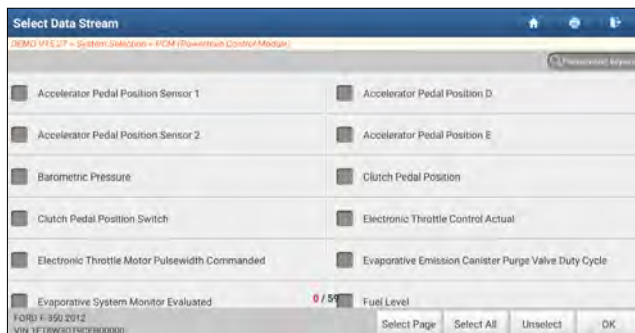

**On-screen Buttons:**

**Select Page:** Tap to select all items of the current page.

**Select All:** Tap to select all items. To select certain data stream item, just check the box before the item name.

**Unselect:** Tap to deselect all data stream items.

**OK:** Tap to confirm and go to the next step.

After selecting the desired items, tap **OK** to enter the data stream reading screen.



**Notes:**

1. Tap **T**, the following popup will appear.

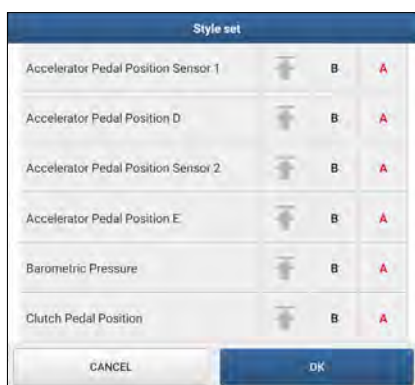

Here the user can set different display style for each selected item.

↑ indicates sticky top. If it is tapped, it will change into ↑. On the data stream display screen, the data stream item with ↑ will be shown on the top of the selected data stream list. To remove it from the top of the list, just tap it again.

B indicates this item will be displayed in **Bold**.

A indicates this item will be displayed in **Red**.

2. Tap **English** or **Metric** to switch the measurement unit.

3. If the value of the data stream item is out of the range of the standard (reference) value, the whole line will display in red. If it complies with the reference value, it displays in blue (normal mode).

4. The indicator 1/X shown on the bottom of the screen stands for the current page/total page number. Swipe the screen from the right/left to advance/return to the next/previous page.

There are 3 types of display modes available for data viewing, allowing you to view various types of parameters in the most suitable way.

- Value – this is the default mode which displays the parameters in texts and shows in list format.
- Graph – displays the parameters in waveform graphs.
- Combine – this option is mostly used in graph merge status for data comparison. In this case, different

items are marked in different colors.

**On-screen Buttons:**

 Tap it to view the waveform graph of the current data stream item.



 Note: The waveform can be zoomed in or out via: Spread apart/pinch together.

To zoom in manually, place two fingers on the screen and then spread them apart. To zoom out, place two fingers apart on the screen and then pinch them together.

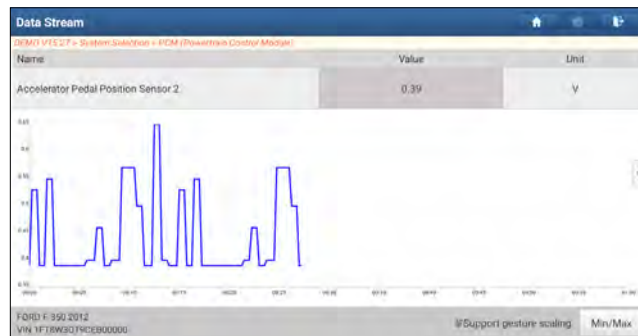

- **Min/Max:** Tap to define the maximum/minimum value. Once the value goes beyond the specified value, the system will alarm.

 Note: The real time (Live Data) vehicle operating information (values/status) that the on-board computer supplies to the tool for each sensor, actuator, switch, etc. is called Parameter Identification Data (PID).

**Graph:** Tap to view the waveforms of the selected data stream items.



- **Combine:** This option is mostly used in graph merge status for data comparison. Select (Maximum 4 data stream items can be selected)/deselect the desired items and then screen will display/remove the waveforms corresponding to these items immediately.

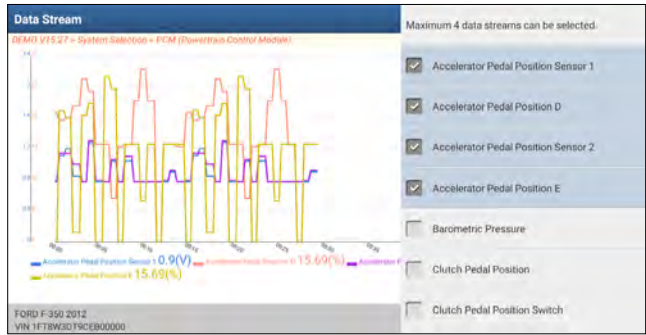

- **Value:** Tap to display the parameters in texts.

**Select Sample DS:** Tap to select the sample DS file, the values you customized and saved in process of data stream sampling will be imported into the **Standard Range** (See below) column for your comparison.

**Note:** Before executing this function, you have to sample the values of data stream items and save it as an sample DS file.

Name	Value	Standard Range(Data Stream Sample)	English	Metric
Accelerator Pedal Position Sensor 1	0.78	1-1.28	V	
Accelerator Pedal Position D	26.27	5.2-27.84	%	
Accelerator Pedal Position Sensor 2	0.38	0.5-0.65	V	
Accelerator Pedal Position E	20.39	0-26.67	%	
Barometric Pressure	99.5	99.5-99.5	kPa	

**Report:** To save the current data as a diagnostic report. All diagnostic reports can be accessed from **User Info -> My Reports -> Health Report**.

**Record:** Tap to start recording diagnostic data. Recorded live data can serve as valuable information to help you in troubleshooting of vehicle problems. All diagnostic records can be replayed from **User Info -> My Reports -> Recorded Data**.

**Note:** The saved file follows the naming rule: It begins with vehicle type, and then the product S/N and ends with record starting time (To differentiate between files, please configure the accurate system time).

**Help:** Tap to view the help information.

**Sample DS:** This item enables you to customize the standard range of live data stream items and save it as DS (Data Stream) sample file. Each time you run the data stream items, you can call out the corresponding sample data to overwrite the current standard range.

Tap it to start recording the sample data, and the following screen will appear:

**Note:** Only the data stream items with measurement units will be recorded.



Tap to stop recording and navigate to the data revision screen.



Tap the Min./Max. value to change it. After modifying all desired items, tap **Save** to save it as a sample DS file. All sample DS files are stored under the **Data Stream Sample** file in **User Info**.

**E. Actuation Test**

This option is used to access vehicle-specific subsystem and component tests. Available test vary by vehicle manufacturer, year, and model. During the actuation test, the tablet outputs commands to the ECU in order to drive the actuators, and then determines the integrity of the system or parts by reading the ECU data, or by monitoring the operation of the actuators, such as switching a injector between two operating states.

Tap **Actuation Test** on the test function selection screen, the system will display as follows:

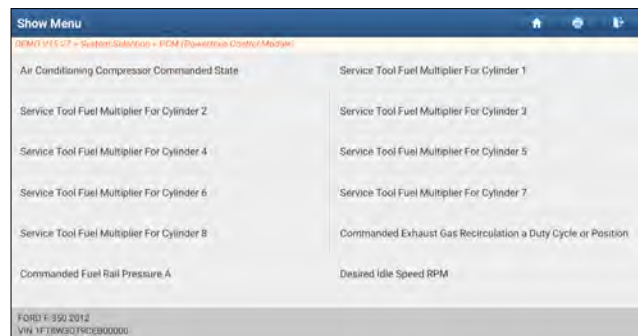

Simply follow the on-screen instructions and make appropriate selections to complete the test. Each time when an operation is successfully executed, **Completed** displays.

**5.3 Diagnostic History**

Generally once a vehicle diagnosis is performed, the tablet will record the every details of diagnostic process. The History function provides a quick access to the tested vehicles and users can resume from the last operation, without starting from scratch.

Tap **Diagnostic History**, all diagnostic records will be listed on the screen in date sequence.



- Tap certain vehicle model to view the details of the last diagnostic report.
- To delete certain diagnostic history, select it and then tap **Delete**. To delete all historical records, tap **Select All** and then tap **Delete**.
- Tap **Quick Access** to directly navigate to the function selection page of last diagnostic operation. Choose the desired option to proceed.

## 5.4 Feedback

This item allows you to feedback your diagnostic problems to us for analysis and troubleshooting.

Tap **Feedback**, the following 3 options will be displayed on the left column of the screen.

### A. Feedback

Tap a tested vehicle model to enter the feedback screen.

- 1) Tap **Choose File** to open the target folder and choose the desired diagnostic logs.
- 2) Choose the failure type and fill in the detailed failure description in the blank text box and telephone or email address. After inputting, tap **Submit Result** to send it to us.

### B. History

Tap it to view all diagnostic feedback records. Different process states are marked with different colors.

### C. Offline list

Tap it to display all diagnostic feedback logs which have not been submitted successfully due to network failure. Once the tablet gets a stable network signal, it will be uploaded to the remote server automatically.



## 6 Maintenance Reset

In addition to amazing & powerful diagnostic function, the tablet also features various service functions. The most commonly performed service functions contain:

- Oil Reset Service
- Electronic Parking Brake Reset
- Steering Angle Calibration
- ABS Bleeding
- TPMS (Tire Pressure Monitor System) Reset
- Gear Learning
- IMMO Service
- Injector Coding
- Battery Maintenance System
- Diesel Particulate Filter (DPF) Regeneration
- Electronic Throttle Position Reset
- Gearbox Matching
- AFS (Adaptive Front-lighting System) Reset
- Sunroof Initialization
- Suspension Calibration
- EGR Adaption
- Seats Calibration
- Tyre Reset
- Coolant Bleed
- AdBlue Reset (Diesel Engine Exhaust Gas Filter)
- NOx Sensor Reset

There are two methods to reset service lamp: Manual reset or Auto reset. Auto reset follows the principle of sending command from the tool to vehicle's ECU to do resetting. While using manual reset, users just follow the on-screen instructions to select appropriate execution options, enter correct data or values, and perform necessary actions, the system will guide you through the complete performance for various service operations.

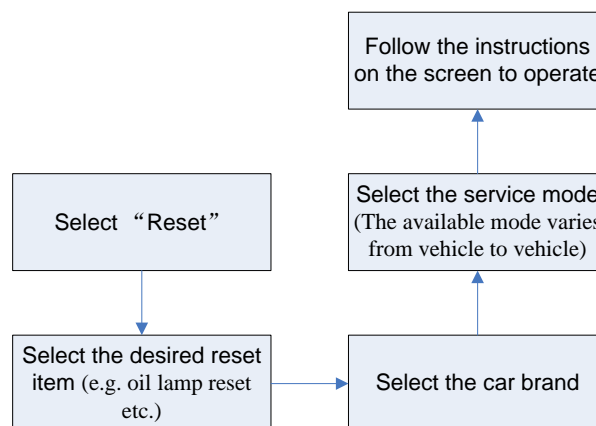

### 6.1 Oil Reset Service

This function allows you to perform reset for the engine oil life system, which calculates an optimal oil life change interval depending on the vehicle driving conditions and climate.

This function can be performed in the following cases:

1. If the service lamp is on, you must provide service for the car. After service, you need to reset the driving mileage or driving time so that the service lamp turns off and the system enables the new service cycle.

2. After changing engine oil or electric appliances that monitor oil life, you need to reset the service lamp.

## 6.2 Electronic Parking Brake Reset

1. If the brake pad wears the brake pad sense line, the brake pad sense line sends a signal sense line to the on-board computer to replace the brake pad. After replacing the brake pad, you must reset the brake pad. Otherwise, the car alarms.
2. Reset must be performed in the following cases:
  - a) The brake pad and brake pad wear sensor are replaced.
  - b) The brake pad indicator lamp is on.
  - c) The brake pad sensor circuit is short, which is recovered.
  - d) The servo motor is replaced.

## 6.3 Steering Angle Calibration

To reset the steering angle, first find the relative zero point position for the car to drive in straight line. Taking this position as reference, the ECU can calculate the accurate angle for left and right steering.

After replacing the steering angle position sensor, replacing steering mechanical parts (such as steering gearbox, steering column, end tie rod, steering knuckle), performing four-wheel alignment, or recovering car body, you must reset the steering angle.

## 6.4 ABS Bleeding

This function allows you to perform various bi-directional tests to check the operating conditions of Anti-lock Braking System (ABS).

1. When the ABS contains air, the ABS bleeding function must be performed to bleed the brake system to restore ABS brake sensitivity.
2. If the ABS computer, ABS pump, brake master cylinder, brake cylinder, brake line, or brake fluid is replaced, the ABS bleeding function must be performed to bleed the ABS.

## 6.5 Tire Pressure Monitor System Reset

This function allows you to quickly look up the tire sensor IDs from the vehicle's ECU, as well as to perform TPMS replacement and sensor test.

1. After the tire pressure MIL turns on and maintenance is performed, the tire pressure resetting function must be performed to reset tire pressure and turn off the tire pressure MIL.
2. Tire pressure resetting must be performed after maintenance is performed in the following cases: tire pressure is too low, tire leaks, tire pressure monitoring device is replaced or installed, tire is replaced, tire pressure sensor is damaged, and tire is replaced for the car with tire pressure monitoring function.

## 6.6 Gear Learning

The crankshaft position sensor learns crankshaft tooth machining tolerance and saves to the computer to more accurately diagnose engine misfires. If tooth learning is not performed for a car equipped with Delphi engine, the MIL turns on after the engine is started. The diagnostic device detects the DTC P1336 'tooth not learned'. In this case, you must use the diagnostic device to perform tooth learning for the car. After tooth learning is successful, the MIL turns off.

After the engine ECU, crankshaft position sensor, or crankshaft flywheel is replaced, or the DTC 'tooth not learned' is present, tooth learning must be performed.

## 6.7 IMMO Service

An immobilizer is an anti-theft mechanism that prevents a vehicle's engine from starting unless the correct ignition key or other device is present. Most new vehicles have an immobilizer as standard equipment. An important advantage of this system is that it doesn't require the car owner to activate it since it operates automatically. An immobilizer is considered as providing much more effective anti-theft protection than an audible alarm alone.



As an anti-theft device, an immobilizer disables one of the systems needed to start a car's engine, usually the ignition or the fuel supply. This is accomplished by radio frequency identification between a transponder in the ignition key and a device called a radio frequency reader in the steering column. When the key is placed in the ignition, the transponder sends a signal with a unique identification code to the reader, which relays it to a receiver in the vehicle's computer control module. If the code is correct, the computer allows the fuel supply and ignition systems to operate and start the car. If the code is incorrect or absent, the computer disables the system, and the car will be unable to start until the correct key is placed in the ignition.

To prevent the car being used by unauthorized keys, the anti-theft key matching function must be performed so that the immobilizer control system on the car identifies and authorizes remote control keys to normally use the car.

When the ignition switch key, ignition switch, combined instrument panel, ECU, BCM, or remote control battery is replaced, anti-theft key matching must be performed.

## 6.8 Injector Coding

Write injector actual code or rewrite code in the ECU to the injector code of the corresponding cylinder so as to more accurately control or correct cylinder injection quantity.

After the ECU or injector is replaced, injector code of each cylinder must be confirmed or re-coded so that the cylinder can better identify injectors to accurately control fuel injection.

## 6.9 Battery Maintenance System Reset

This function enables you to perform a resetting operation on the monitoring unit of vehicle battery, in which the original low battery fault information will be cleared and battery matching will be done.

Battery matching must be performed in the following cases:

- a) Main battery is replaced. Battery matching must be performed to clear original low battery information and prevent the related control module from detecting false information. If the related control module detects false information, it will invalidate some electric auxiliary functions, such as automatic start & stop function, sunroof without one-key trigger function, power window without automatic function.
- b) Battery monitoring sensor. Battery matching is performed to re-match the control module and motoring sensor to detect battery power usage more accurately, which can avoid an error message displaying on the instrument panel.

## 6.10 Diesel Particulate Filter (DPF) Regeneration

DPF regeneration is used to clear PM (Particulate Matter) from the DPF filter through continuous combustion oxidation mode (such as high temperature heating combustion, fuel additive or catalyst reduce PM ignition combustion) to stabilize the filter performance.

DPF regeneration may be performed in the following cases:

- a) The exhaust back pressure sensor is replaced.
- b) The PM trap is removed or replaced.
- c) The fuel additive nozzle is removed or replaced.
- d) The catalytic oxidizer is removed or replaced.
- e) The DPF regeneration MIL is on and maintenance is performed.
- f) The DPF regeneration control module is replaced.

## 6.11 Electronic Throttle Position Reset

This function enables you to make initial settings to throttle actuators and returns the learned values stored on ECU to the default state. Doing so can accurately control the actions of regulating throttle (or idle engine) to adjust the amount of air intake.

## 6.12 Gearbox Matching

1. This function can complete the gearbox self-learning to improve gear shifting quality.
2. When the gearbox is disassembled or repaired (after some of the car battery is powered off), it will lead

to shift delay or impact problem. In this case, this function needs to be done so that the gearbox can automatically compensate according to the driving conditions so as to achieve more comfortable and better shift quality.

### 6.13 AFS (Adaptive Front-lighting System) Reset

This feature is used to initialize the adaptive headlamp system. According to the ambient light intensity, the adaptive headlamp system may decide whether to automatically turn on the headlamps, and timely adjust the headlamp lighting angle while monitoring the vehicle speed and body posture.

### 6.14 Sunroof Initialization

This function can set the sunroof lock off, closed when it rains, sliding / tilting sunroof memory function, temperature threshold outside the car etc.

### 6.15 Suspension Calibration

1. This function can adjust the height of the body.
2. When replacing the body height sensor in the air suspension system, or control module or when the vehicle level is incorrect, you need to perform this function to adjust the body height sensor for level calibration.

### 6.16 EGR Adaption

This function is used to learn the EGR (Exhaust Gas Recirculation) valve after it is cleaned or replaced.

### 6.17 Seats Calibration

This function is applied to match the seats with memory function that are replaced and repaired.

### 6.18 Tyre Reset

This function is used to set the size parameters of the modified or replaced tire.

### 6.19 Coolant Bleed

Use this function to activate the electronic water pump before venting the cooling system.

### 6.20 AdBlue Reset (Diesel Engine Exhaust Gas Filter)

After the diesel exhaust treatment fluid (car urea) is replaced or filled up, urea reset operation is required.

### 6.21 NOx Sensor Reset

NOx sensor is a sensor used to detect the content of nitrogen oxides (NOx) in engine exhaust. If the NOx fault is re-initialized and the NOx catalytic converter is replaced, it is necessary to reset the catalytic converter learned value stored in the engine ECU.

## 7 Software Update

This module allows you to update the diagnostic App and frequently used software.

### 7.1 Update Diagnostic Software & APP

Go to **Software Update** on the Job Menu and tap the **Downloaded** tab.

The **Available** tab displays a list of software that can be updated. Under it, all software is categorized into three kinds:

- **Common software:** mainly includes some common apps that are associated with the diagnostic app. The software of this kind always stays at the top of the list, which can be deselected manually (excluding the system app, such as firmware and ECU aid).
- **Frequently used vehicle software:** refers to the diagnostic software that is frequently used, including the vehicle diagnostic software and Reset software. It is generally displayed following the **Common software** list.
- **Other vehicle software:** refers to the diagnostic software that is rarely used or never used. It is generally displayed following the **Frequently used software** list.
  - 1). If the user does not download any diagnostic software during the sign-up process, all diagnostic software is selected by default. Tap **Update** to start downloading.
  - 2). If the user downloaded all/some vehicle software during the sign-up process and had it serviced for a long period of time, only the frequently used software is selected. Tap **Update** to start downloading. Other vehicle software that is rarely used will also be listed under the **Available** tab, but it is not selected at default.

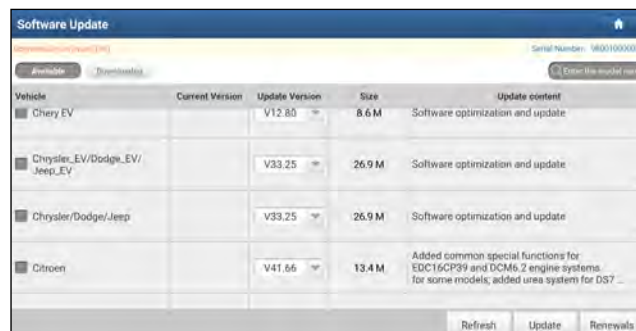

To download certain software that is not frequently used, check the box before the vehicle model. Tap **Update** to start downloading.

Once download is finished, the software packages will be installed automatically.

### 7.2 Update Frequently Used Software

If the user only intends to update the frequently used software, go to **Software Update** and tap the **Downloaded** tab.

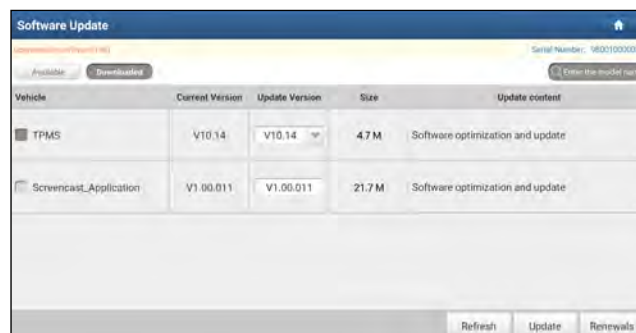

Tap **Update** to start downloading. Once download is finished, the software packages will be installed automatically.

## 7.3 Renew Subscription

If the software subscription is due or expires, the system will prompt you to renew your subscription and a **Renewal** button will appear on the bottom of the update page.

Tap **Renewal** to navigate to the payment screen.

There are two ways available for you to make payment: PayPal and Subscription Renewal Card (\*need to buy it from the local dealer where you purchased the tool).

### A. Using PayPal

1. Tap **Renewal** on the update page to navigate to the renewal type selection screen.
2. Select **PayPal**, and then follow the on-screen instructions to finish the transaction.
3. After payment, go to update center to update the diagnostic software.

### B. Using Subscription Renewal Card

1. Tap **Renewal** to navigate to the renewal type selection screen.
2. Select **Subscription Renewal Card**.

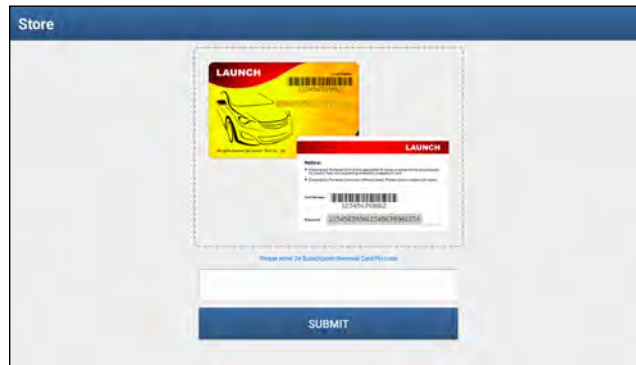

3. Input the 24-digit password of Subscription Renewal Card and then tap **Submit** to finish the renewal.
4. Go to the update center to update the diagnostic software.

## 8 SmartLink Diag.

### 8.1 Introduction

SmartLink is a newly developed powerful service system dedicated to remote vehicle diagnosis and service. In the SmartLink ecology system, if a technician (SmartLink C) does not have time to puzzle through a touch vehicle problem, he can seek a trusted second opinion or additional expertise on various vehicle issues from remote master technicians or repair shops (SmartLink B). SmartLink B enables the shop owner to greatly increase customer’s retention and boost shop revenue by providing the professional technical assistance service.

It mainly consists of the following parts:

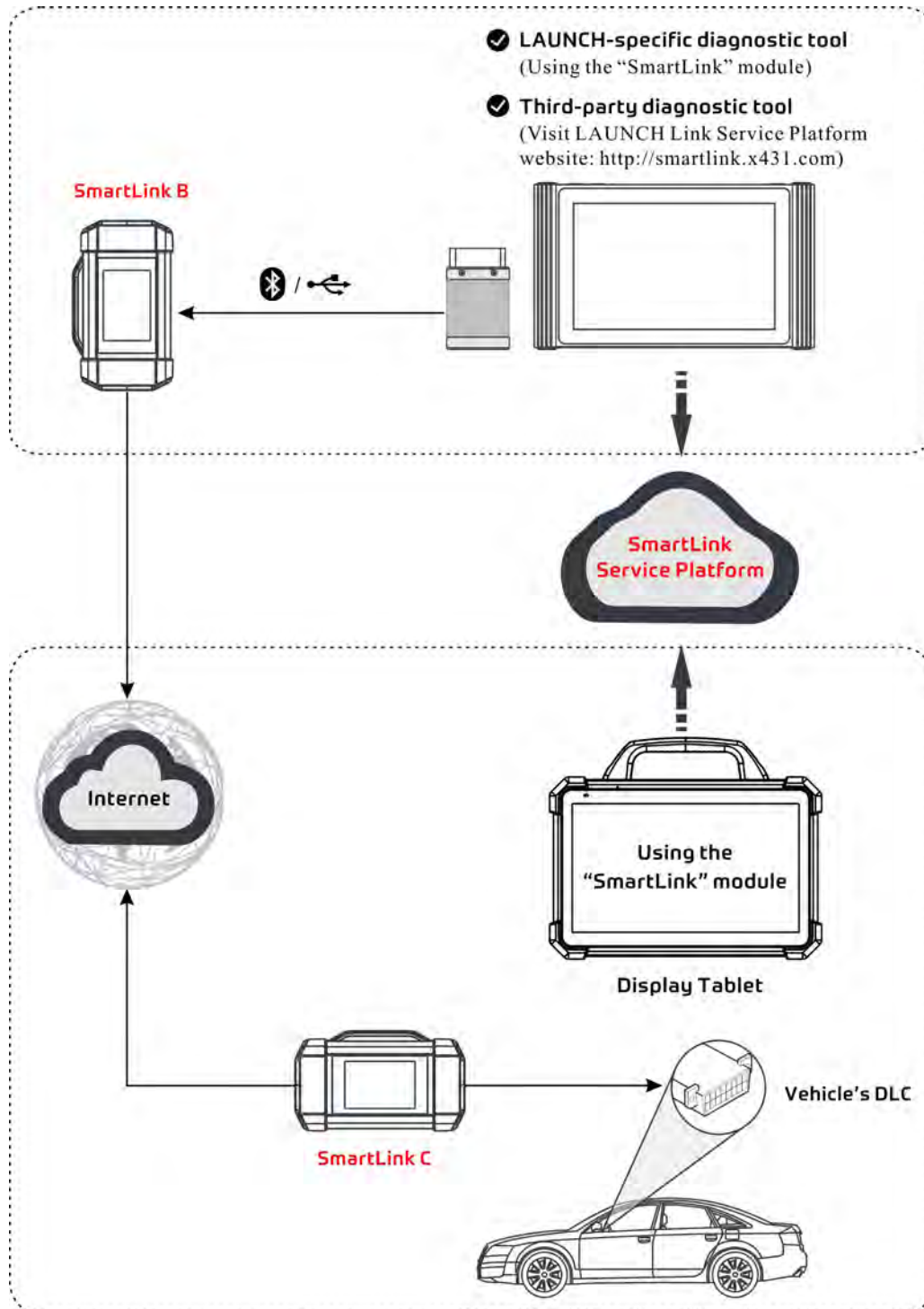

- **SmartLink Service Platform** – It can be accessed from the SmartLink module of the tablet. There are two modules available on the link service platform: **I'd like a remote assistance (for SmartLink C)** and **I am a remote technician (for SmartLink B)**.
  - **SmartLink C (Customer) - SmartLink Service Subscriber.** In the SmartLink system, the SmartLink A has an I'd like a remote assistance module on the SmartLink Service Platform for submitting remote repair orders plus a SmartLink A dongle for accessing vehicle data. It supports remote diagnostic services for vehicles that meet CAN / CAN FD / J2534 vehicle diagnostic standards.
1. Launch Service Link Platform: Binds SmartLink C dongles and submits remote repair orders.



2. SmartLink C Dongle: Connects to the vehicle's DLC port for collecting the vehicle data and sends it to the remote SmartLink B.

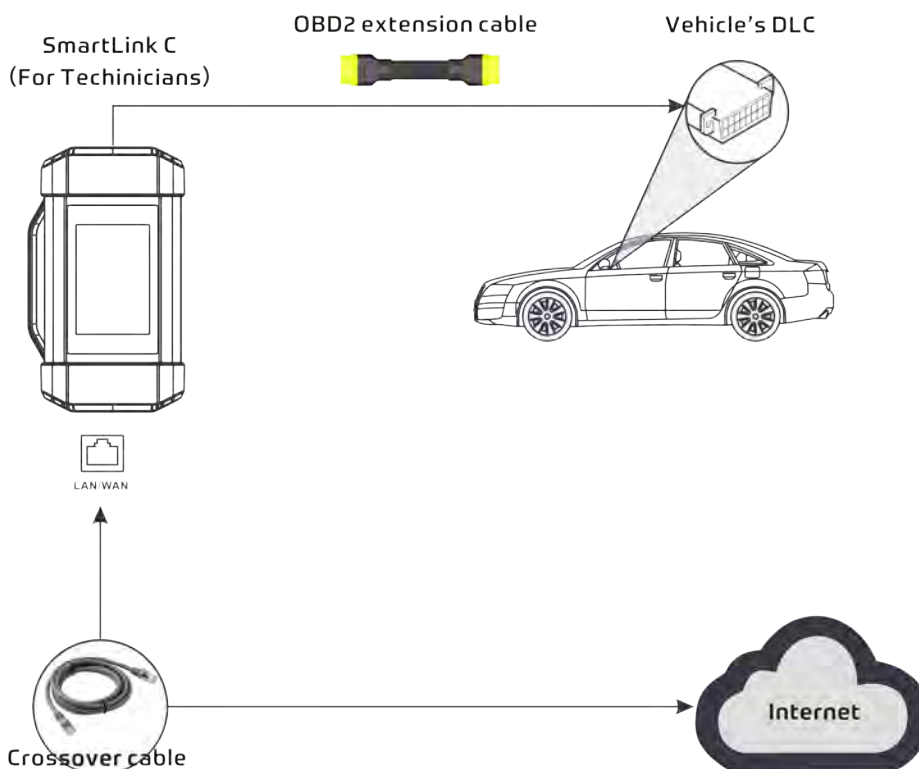

- **SmartLink B (Business) - SmartLink Service Provider.** In the SmartLink system, the SmartLink B has an I am a remote technician module on the SmartLink Service Platform for accepting the orders from SmartLink C plus a SmartLink B dongle for providing hardware support.
1. Launch Service Link Platform: Binds SmartLink B dongles and accepts orders from SmartLink C.
  - If the SmartLink B dongle works with the LAUNCH-specific diagnostic tool equipped with SmartLink module, tap **SmartLink** to add the SmartLink B device and accepts orders on the diagnostic tool.
  - If the SmartLink B dongle works with the third-party diagnostic tool, open the browser and visit SmartLink Service Platform website <http://smartlink.x431.com> (web client) to add the SmartLink B device and accepts orders in the browser.



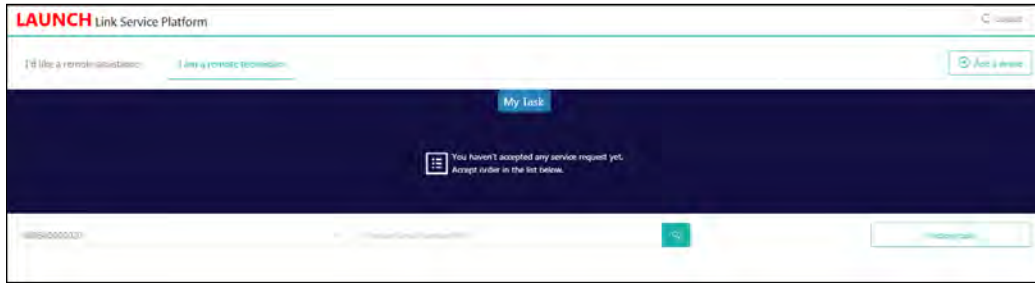

2. SmartLink B Dongle: After accepting the orders, it can work with the compatible diagnostic tool to perform diagnosis of the vehicle connected to the SmartLink C dongle.

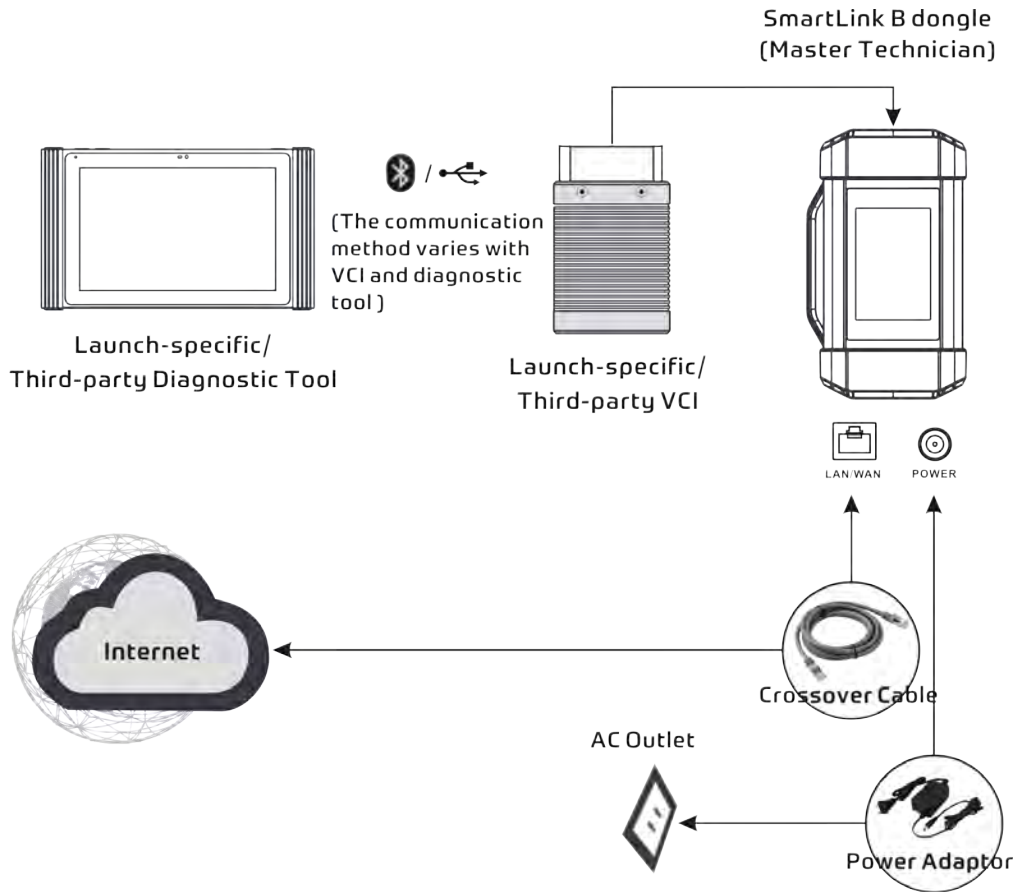

## 8.2 Perform SmartLink Remote Operation

### 8.2.1 Posting remote assistance request

1. Tap **SmartLINK** on the Job menu of the tablet. The tablet automatically logs in the SmartLink system.



On-screen buttons:

- **Logout:** Exits the current account from the system.
  - **Add a device:** Binds more SmartLink C device to the current account.
  - **Post request:** Submits a new remote assistance order.
2. Tap the **Post Request** button to fill in the following information.



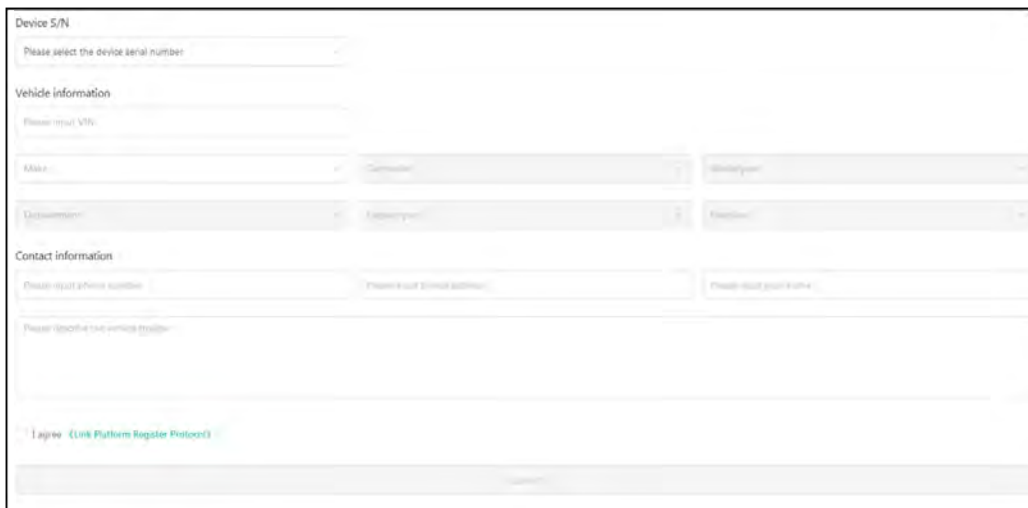

- In the **Device S/N** column, choose the desired SmartLink C Serial Number from the pull-down list if several SmartLink C is bound to the current account.
- In the **Vehicle information** column, enter the VIN manually and choose the right Make, Car model, Model year, Displacement, Engine type and Function.

 Note: In general, vehicle identification numbers are standardized - all contain 17 characters. VIN characters may be capital letters A through Z and numbers 1 through 0; however, the letters I, O and Q are never used in order to avoid mistakes of misreading. No signs or spaces are allowed in the VIN.

- In the **Contact information** column, input the phone number, E-mail address and name so that you can be reached by the remote SmartLink B in the shortest time.
  - In the **Problem Description** input box, it is highly recommended to describe the vehicle failure as accurate as possible because it is very helpful for the SmartLink B to have a general understanding of the vehicle status.
  - Tap **Link Platform Register Protocol** to read it carefully. After reading it, select the checkbox **I agree**.
3. After filling the information, tap **Submit** to create the order.

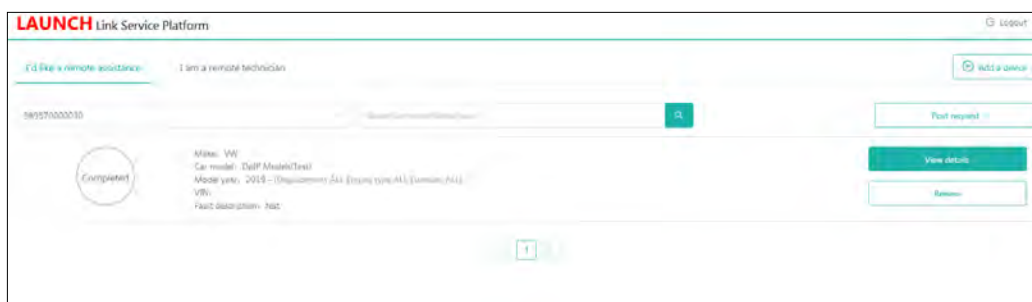

On-screen buttons:

- **View details:** Double check if the order information is correct or not.
- **Review:** Rates the service that has been already finished.

4. Next refer to Chapter 8.2.2 to make connections and start the diagnosis.

 Note: The remote SmartLink operation can only be performed after the SmartLink C has submitted the request, and this request has been accepted by the remote SmartLink B.

### 8.2.2 Connections & operations

Follow the steps below to proceed:

1. Turn off the vehicle ignition.
2. Connect one end of the OBD II extension cable into the OBD-16 diagnostic port of the SmartLink C

device, and the other end into the vehicle's DLC port.

**Note:** During the SmartLink diagnosis, especially during remote online programming, it is recommended that the vehicle battery is connected to a charging power source. Doing so can prevent the vehicle from running out of power and failing to start due to long diagnosis time.

3. Plug one end of CAT-6 crossover cable into the LAN/WLAN port of the SmartLink C device, and the other end into the LAN port of network modem.

**Note:** The network broadband of 100MB and above is required for this operation.

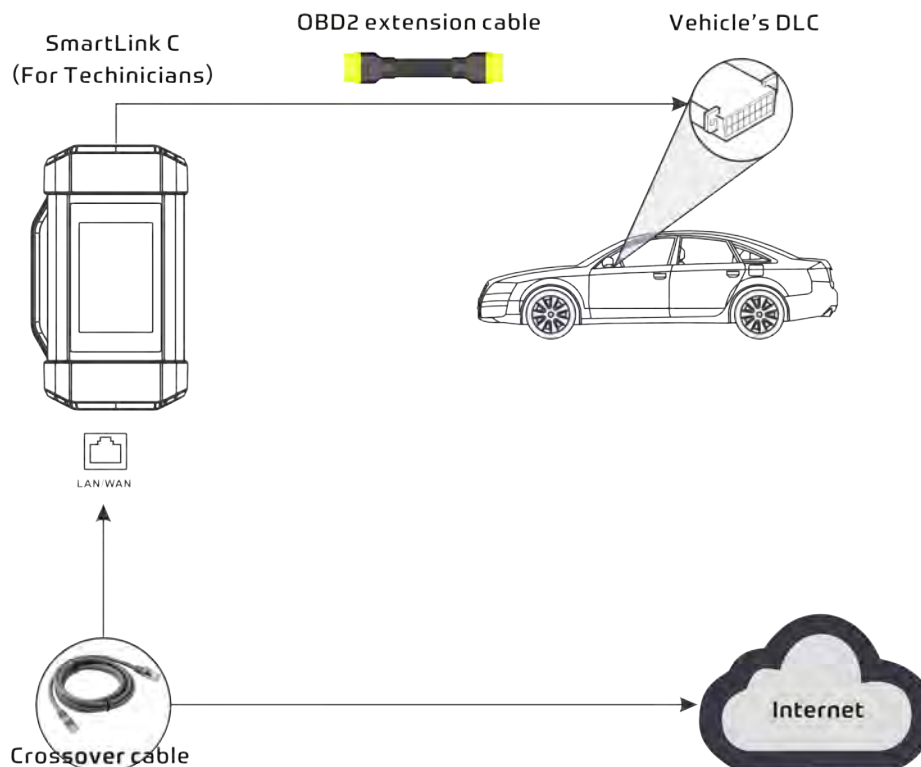

4. After a successful network connection, the SmartLink C screen displays prompt information asking whether to enter the super remote diagnostic mode. Tap **Yes**, the system will automatically read the vehicle information and connect to the remote diagnosis server.

**Note:** One SmartLink C can only accept one remote diagnostic operation at one time.

5. Turn on the vehicle ignition.

**Note:** After receiving the order, the SmartLink B master technician will accept the order and contact you via phone or E-mail address.

6. After a successful connection between the SmartLink C and SmartLink B is established, the following message will be displayed on the SmartLink C screen.

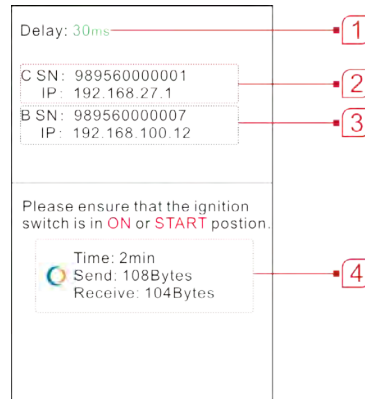

1 - Network delay status: Indicates the quality of the current network. Different colors represent different delay status. There are three states of network delay:

- Green: Indicates the network is normal. It is recommended that the diagnosis operation be performed when the network delay is green. Otherwise, the communication with the vehicle may fail or the incorrect system detection may occur.
- Yellow: Indicates the network is not stable. Please keep it stable.
- Red: Indicates the network delay is serious and not suitable for remote diagnosis or the network is disconnected.



Note: If the displayed network is poor, there may be too many people using the network in the LAN and some users are downloading. It is recommended to use a stable network for remote diagnosis.

2 - The Serial Number and IP address of the current SmartLink C device.

3 - The Serial Number and IP address of the connected SmartLink B device.

4 - The duration of diagnosis process and package size of sent data/received data.



Notes:

- Please do not interrupt the vehicle or network connection during a remote diagnostic process.
- Please make sure that the network delay is in green state when performing a remote online programming process.

7. Unplug the crossover cable when a SmartLink operation is completed.

## 9 TPMS

This module allows you to configure the tablet as TPMS activation & diagnostic tool, which provides the ability to trigger TPMS sensor, program TPMS sensor, perform the relearning procedure. It needs to work with the X-431 TSGUN device (sold separately).



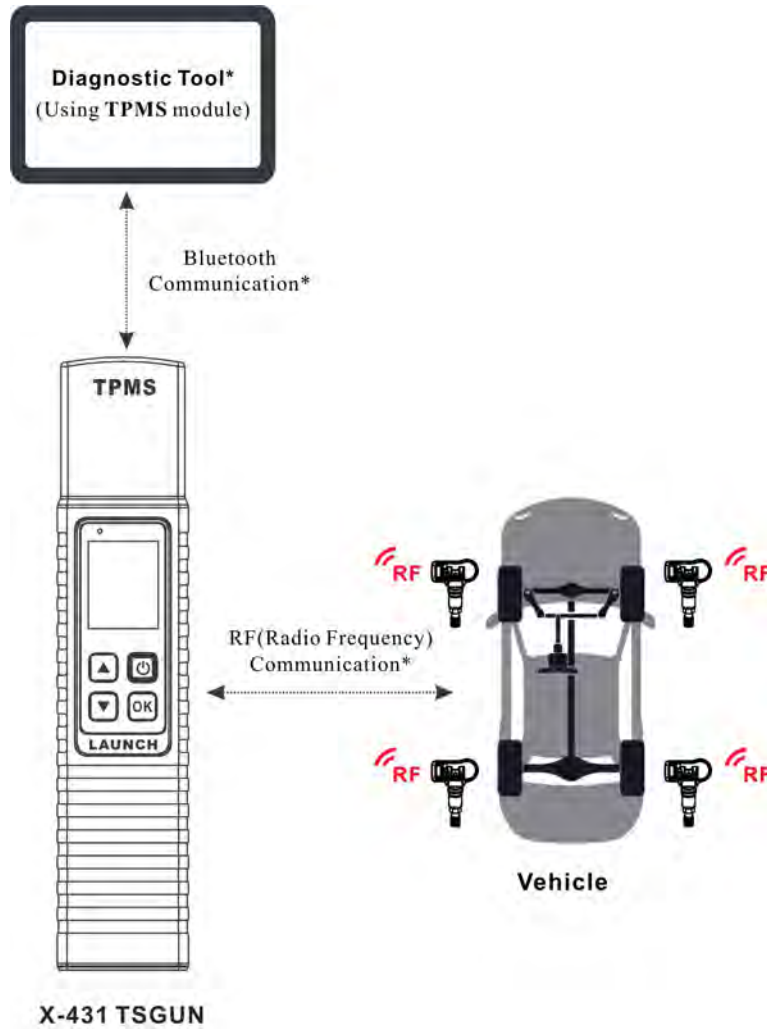

### 9.1 Working Principle



Below illustrates how the tablet works with the X-431 TSGUN.

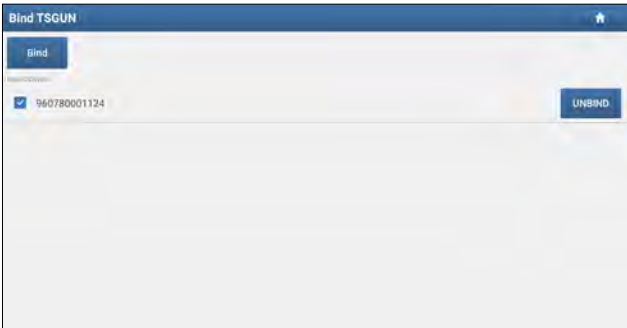
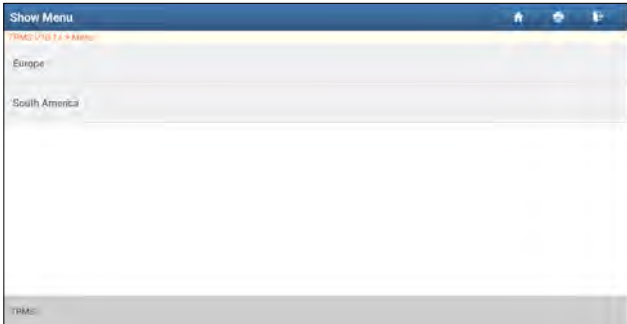

## 9.2 Operation Flowchart

Below illustrates how the tablet works with the X-431 TSGUN (Take **Mercedes-BENZ** for example).

Steps	Corresponding Screenshots
<p><b>Step 1</b> - Tap <b>TPMS</b> on the diagnostic tool</p>	
<p><b>Step 2</b> - Select the desired X-431 TSGUN from the Bound device list</p> <p> <b>Note:</b> This step shall apply when multiple X-431 TSGUN devices are bound to the diagnostic tool. If only one X-431 TSGUN is bound to the diagnostic tool, keep the device ON and tap <b>OK</b> to ignore this step. If it is your first time using the X-431 TSGUN, please bind it before doing any TPMS operations. See Chapter 9.3 for more details on binding/unbinding.</p>	
<p><b>Step 3</b> - Select target region</p>	
<p><b>Step 4</b> - Select vehicle manufacturer</p>	

<p><b>Step 5</b> - Select vehicle model and year</p>																															
<p><b>Step 6</b> - Select the TPMS function and follow on-screen instructions to proceed. For more details on TPMS functions, see the User Manual of the X-431 TSGUN.</p> <p> <b>Note:</b> For indirect TPMS vehicle, only the Learning function is supported. For vehicle using Direct TPMS, it generally includes: Activation, Programming, Learning and Diagnosis. The available TPMS functions may vary for different vehicles being serviced.</p>	 <table border="1" data-bbox="1002 707 1337 864"> <thead> <tr> <th></th> <th>ID(HEX)</th> <th>kPa</th> <th>MHZ</th> <th>°C</th> <th>Battery status</th> </tr> </thead> <tbody> <tr> <td>FL</td> <td></td> <td></td> <td></td> <td></td> <td></td> </tr> <tr> <td>FR</td> <td></td> <td></td> <td></td> <td></td> <td></td> </tr> <tr> <td>RR</td> <td></td> <td></td> <td></td> <td></td> <td></td> </tr> <tr> <td>RL</td> <td></td> <td></td> <td></td> <td></td> <td></td> </tr> </tbody> </table>		ID(HEX)	kPa	MHZ	°C	Battery status	FL						FR						RR						RL					
	ID(HEX)	kPa	MHZ	°C	Battery status																										
FL																															
FR																															
RR																															
RL																															

## 9.3 Binding/Unbinding

### 9.3.1 Binding

For initial use, user needs to bind the X-431 TSGUN to the diagnostic tool.

1. Tap **TPMS** on the Job menu.

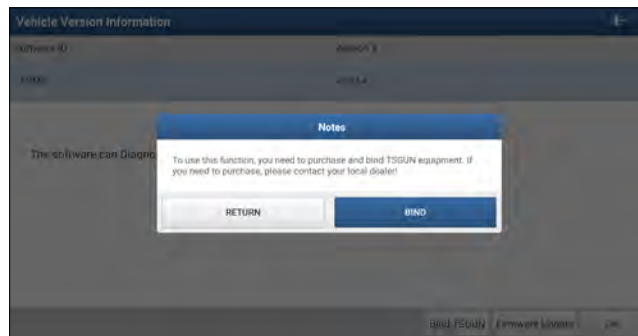

2. Tap **Bind TSGUN** to enter.

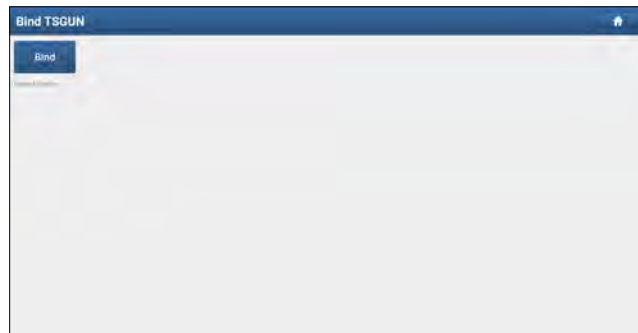

3. Tap **Bind**, the following screen will pop up.

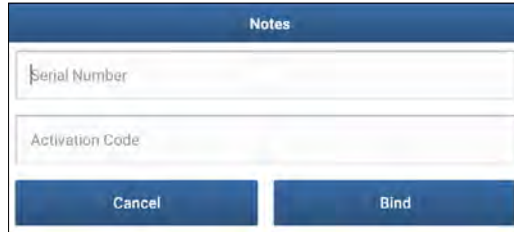

**Note:** Serial Number is a 12-digit number starting with 90002 - you can find it on the back of the tool/from the password envelope. Activation Code is a 8-digit number stored in the password envelope included with the device.



4. Enter the required information. After inputting, tap **Bind**. It will be displayed in the Bound list automatically.

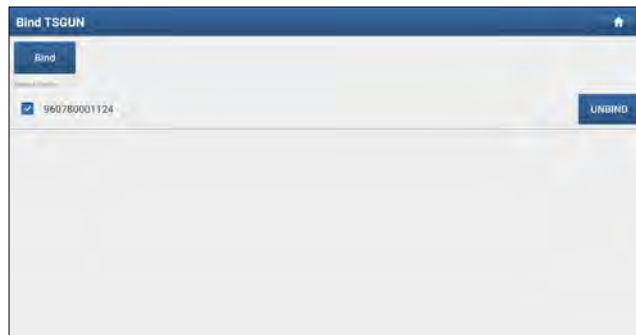

Repeat steps 3~4 to bind multiple X-431 TSGUN devices to the tablet.

### 9.3.2 Unbinding

This function enables you to unbind the X-431 TSGUN and use it on other diagnostic tools.

Follow the steps below to proceed:

1. Tap **TPMS** on the Job menu.
2. Tap **Bind TSGUN** to enter.

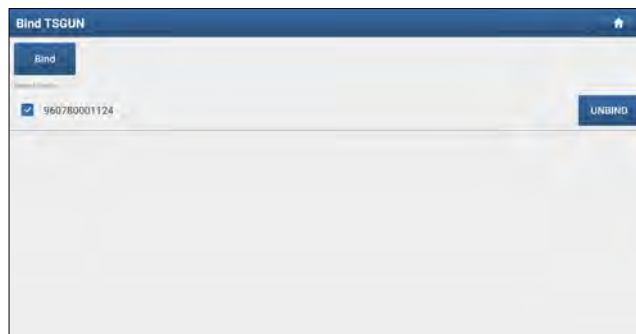

3. Tap **UNBIND**, and then tap **YES** in the pop-up dialog box. It will disappear from the Bound list.



## 10 ADAS

Advanced Driver Assistance Systems (ADAS) are electronic components in vehicles, which include a wide range of safety features for vehicles such as autonomous emergency braking (AEB), lane departure warning (LDW), lane keep assist, blind spot elimination, night vision cameras and adaptive lighting.

The cameras and sensors used by these systems have to be precisely calibrated and adjusted. Incorrect calibration resulting from windscreen replacement or wheel alignment can cause the system to deliver incorrect results or even fail completely, resulting in a serious accident or even a fatality.

The ADAS feature on this diagnostic tool is disabled by default and user needs to activate this feature with the Activation Code (optional) before performing this function. Moreover, it also requires the diagnostic tool to work with the ADAS calibration tool manufactured by LAUNCH (calibration tools from other manufacturers will not be supported). As a comprehensive and flexible calibration tool, the ADAS calibration tool enables you to effectively and accurately calibrate a wide range of camera-based & radar-based driver assistance systems, e.g. the front camera for the lane departure warning system, the radar sensor for the ACC (Adaptive Cruise Control) or the camera for adaptive headlights.

Follow the steps below to activate it.

1. Tap **ADAS** on the Job Menu.

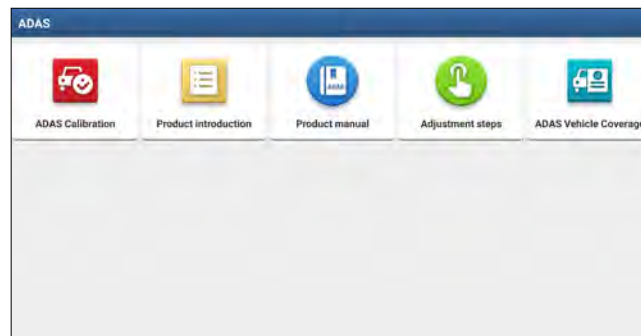

The following functions are included in this module:

- **ADAS Calibration:** This option allows you to activate the ADAS function on this tool.
- **Product Introduction:** A brief introduction of the ADAS calibration tool.
- **Product Manual:** The user manual of the ADAS calibration tool is available for easy retrieval and reference.
- **Adjustment Steps:** The detailed adjustment steps on how to calibrate the ADAS calibration tool.
- **ADAS Vehicle Coverage:** Checks all vehicle models that the ADAS calibration tool covers.

2. Tap **ADAS Calibration**.
3. Tap **Activate** to enter the ADAS activation screen.

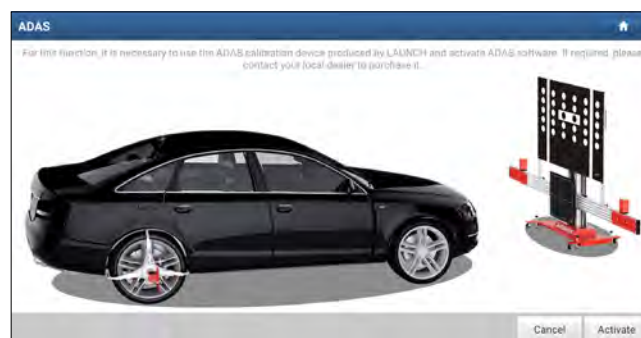

4. Scratch or scrap the designated area on the Activation Card to reveal the password, and input the 24-digit password to activate it.



5. Now the ADAS function becomes accessible and is ready for use.

# 11 User Info

## 11.1 My Report

This option is used to view, delete or share the saved reports.

Tap **My Report**, there are total 3 options available.

In case the DTC result is saved on Read Trouble Code page, the files will be listed under the **Health Report** tab.

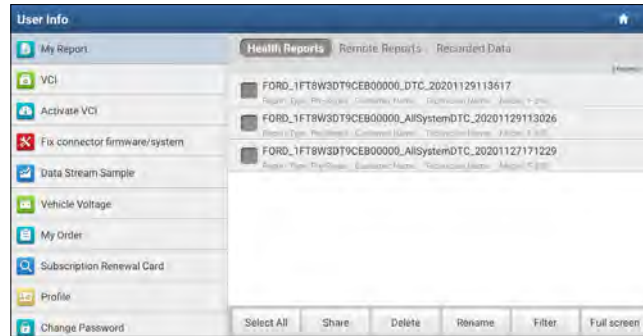

- To select certain report, check the box before the report. To select all reports, tap **Select All**. To deselect all, tap **Unselect**.
- To share the report with others, select the desired one and then tap **Share**.
- Select the desired report and then tap **Delete** to delete it.
- To change the filename of report, tap **Rename**.
- To quickly locate the desired report, tap **Filter**.
- To exit the full screen, tap **Exit full screen**.

If user records the running parameters while reading data stream, it will be saved as .x431 file and appear under the **Recorded Data** tab.

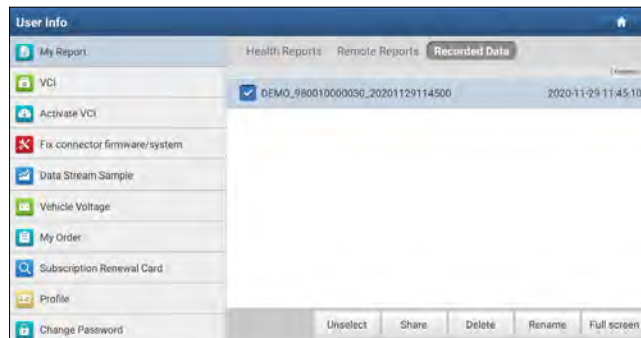

Tap the desired one to enter:



Select the desired data stream items and tap **OK** to jump to the playback page:



Name	Value	Metric
Accelerator Pedal Position Sensor 1	1.04	V
Accelerator Pedal Position D	7.06	%
Accelerator Pedal Position Sensor 2	0.53	V
Accelerator Pedal Position E	24.71	%
Barometric Pressure	99.5	Kpa

On-screen Buttons:

Graph – displays the parameters in waveform graphs.

Value – this is the default mode which displays the parameters in texts and shows in list format.

Combine – this option is mostly used in graph merge status for data comparison. In this case, different items are marked in different colors.

Frame Playback – plays back the recorded data stream items frame by frame. Once it is in frame playback mode, this button changes into **Auto Playback**.

**Remote Diagnostic Report** lists all diagnostic reports generated in process of remote diagnosis.

## 11.2 VCI

This option allows you to manage all your activated VCI devices.

If several VCIs are activated on this tool, a list of VCIs will be displayed on the screen. Once you choose the VCI that belongs to other account, you have to log out, and then input the right account to continue.

## 11.3 Activate VCI

This item lets you activate the SmartLink C device in case you ignore the Activate VCI step in process of the product sign-up.



Input the Serial Number and Activation Code, and then tap **Activate** to activate it.

For details on how to obtain Activation Code, tap the link below to get help.

## 11.4 Fix connector firmware/system

Use this item to upgrade and fix diagnostic firmware. During fixing, please do not cut power or switch to other interfaces.

## 11.5 Data Stream Sample

This feature allows you to manage the recorded data stream sample files.

## 11.6 Vehicle Voltage

This item is used to detect the voltage of the currently tested vehicle when the SmartLink C device is plugged into the vehicle's DLC.

## 11.7 My Order

This item allows you to check the status of all your orders.

## 11.8 Subscription Renewal Card

This item is used to check the status of the subscription renewal card.

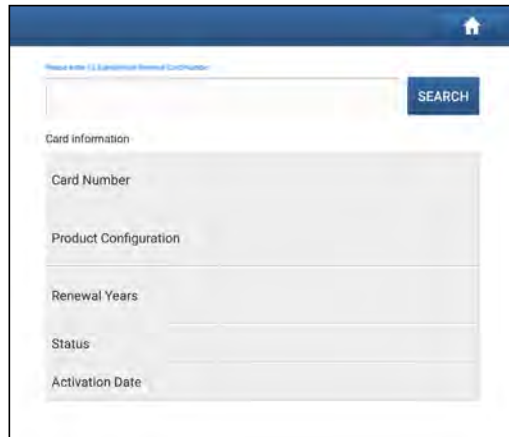

1. Input the 12-digit subscription renewal card number.
2. Tap **Search** to get the search result.

## 11.9 Profile

Use this item to view and configure personal information.

- Tap the user image to change it.
- Tap > next to **Free Upgrade Period** to check the due date of all diagnostic software.

## 11.10 Change Password

This item allows you to modify your login password.

## 11.11 Settings

It enables you to make some application settings and view software version information etc.

### 11.11.1 Units

It is designed to configure the measurement unit. Metric System and English System are available.

### 11.11.2 Shop Information

This option lets you define your print information. It mainly includes Workshop, Address, Telephone, Fax and License Plate.

After inputting, tap **Save**.

Once you saved the print information, it will be entered automatically in the **Add Information** box every time you save the diagnostic report.

### 11.11.3 Printer Set

This option is used to establish a wireless connection between the tablet and the printer (sold separately) while performing printing operations.

The App is compatible with the “LAUNCH Wi-Fi Printer” (sold separately) and “System” printer (external printers loaded with Wi-Fi hotspot).

A. For **LAUNCH Wi-Fi mini printer**, follow the steps below to connect the printer.

1. Tap **Printer Set**.



A. If it is the first time you have operated this printer, please proceed the following:

2. For initial use, you are suggested to reset the printer: Press and hold [MODE] & [FEED] for 8 seconds, the following resetting command will be printed out:

at + default = 1

ok

at + reboot = 1

rebooting...

3. Tap **Reset** to configure Wi-Fi printer.

Step 1: Connect the printer:

Tap **Scan** to start scanning and select the desired printer hotspot named with X-431PRINTER-XXXX (XXXX stands for 4 characters), and then tap **Connect** to enter Step 2.

Step 2: Join the Wi-Fi printer into LAN:

Tap **Scan** to select the desired local Wi-Fi network from the list, and type in the security password (If it is an open network, password is not required), and then tap **Confirm**.

4. Once the Wi-Fi network of the printer is connected and the printer is found, tap **Printing test** to test the printing.

Now you can use the Wi-Fi printer to print!

If the printer is not found, please reset the printer to default factory settings (refer to Step 2 for details) and check whether the current device and the printer are on the same LAN.

B. If you have configured the Wi-Fi printer to the LAN:

2. Tap **Connect to Printer**:

- If the local network remains as it is, tap **Test Print** directly to test the printing.
- If the local network changes, you have to reset the Wi-Fi printer.

B. For other Wi-Fi printers.

Before printing, make sure the following conditions are met:

- The Wi-Fi printer is powered on and working normally.
- The print service plug-in associated with the printer is already installed on the tablet (Go to Google Play or use the Browser to download and install it).

Follow the steps below to proceed:

- Set the default printer as System.
- Go to **Settings -> Network & Internet -> Wi-Fi**, set the WLAN switch to Off.
- On the report/data stream details page, tap .



4. Tap ▼ next to Select a printer on the upper left corner of the screen.

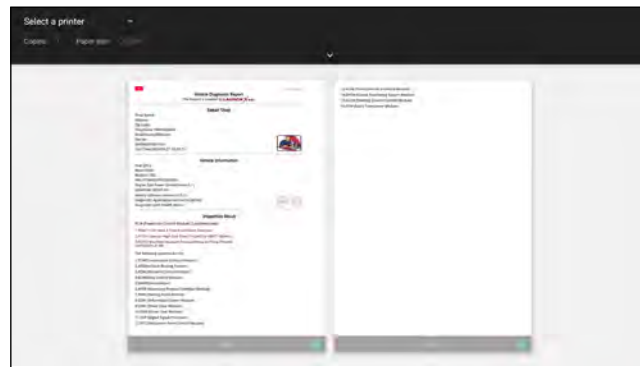

5. Select **All Printers** -> **Add printer** and enable the installed printer service, the system starts searching for all available Wi-Fi printers of the brand.

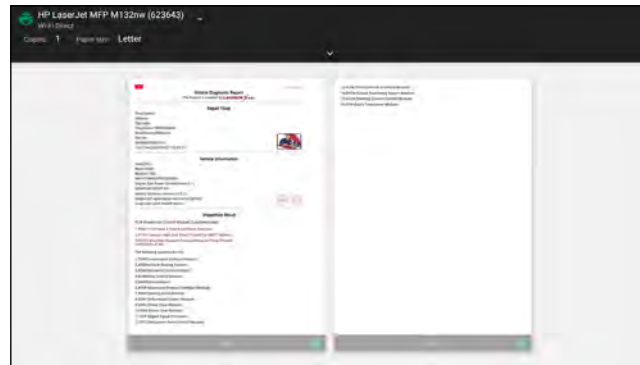

- 6. Select the desired Wi-Fi printer from the list. If the chosen Wi-Fi printer hotspot is open, the tablet can connect it directly. If it is encrypted, a password may be required. Refer to the Wi-Fi printer user manual to get the default password.
- 7. Now the printer is ready for printing.
- 8. Alternatively, you can also choose Save as PDF to save the current diagnostic report as a PDF file for later printing.

### 11.11.4 Clear Cache

This item is used to clear the App cache.

Tap **Clear Cache**, a pop-up window will appear on the screen. Tap **OK** to clear cache and the system will restart the App.

### 11.11.5 About

The software version information and disclaimer are included.



### 11.11.6 Diagnostic Software Auto Update

This option is used to set whether automatic update function is ON.

### 11.11.7 Login/Exit from current account

To logout the current user ID, tap **Logout**.

To login the system again, tap **Login**.

## 11.12 Diagnostic Software Clear

This item allows you to hide/clear the diagnostic software that is not frequently used.

Tap **Diagnostic Software Clear**, the following screen will appear:



Under the **Hide Software** tab, select the desired software logo (a **checkmark** will show in the checkbox located at the lower right corner) and tap **Hide**, it will become invisible. Tap **Unhide** to undo the hide operation.

Under the **Remove Software** tab, select the desired software logo and tap **Delete**, it will disappear from the screen.

**Note:** Removing software may completely delete the software from the tablet. If some software is not used and the tablet runs out of space, you can use this feature to remove it. To re-download it, go to **Update -> Available**.

## 12 Others

### 12.1 Remote Diagnose

This option aims to help repair shops or technicians launch instant messaging and remote diagnosis, making the repair job getting fixed faster.

#### 12.1.1 Interface Layout

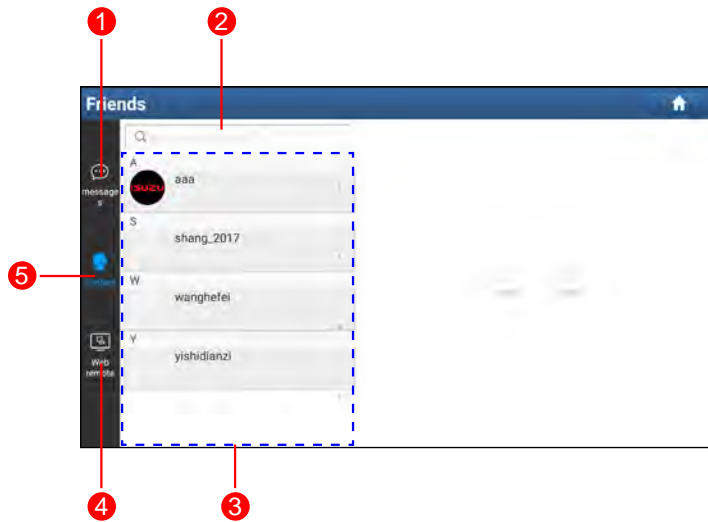

1	Message tab	Once an incoming message reaches, a red dot will appear on the upper right corner of the tab.
2	Search bar	Directly input the login username of the tablet (App) to start searching, and then tap the desired one to add it into your friend list.
3	Friends List	By default, the screen appears blank.
4	WEB Remote switch	Tap to slide the switch to ON, the tablet keeps online and becomes visible on the web client. In this case, inform the technician of your product S/N, and he/she will control your tablet remotely.
5	Contacts tab	Tap to enter the friend list.

#### 12.1.2 Add Friends

Although the remote diagnostics can be performed normally even if the partner may be not your friend, you are suggested to create a Contacts list for future experience exchange and communication among the technician fellows.

Tap **Contacts**. By default it appears blank.

In the search bar, input the partner's username and tap **Search** button next to the search bar to start searching from Launch's technician database.

The partner must be the users who have registered their Launch's diagnostic tools. They may be the following:

- Workshop
- Technician
- golo users

Once the result matches the keyword, the following screen will appear:



Tap the user image, the following screen will appear.

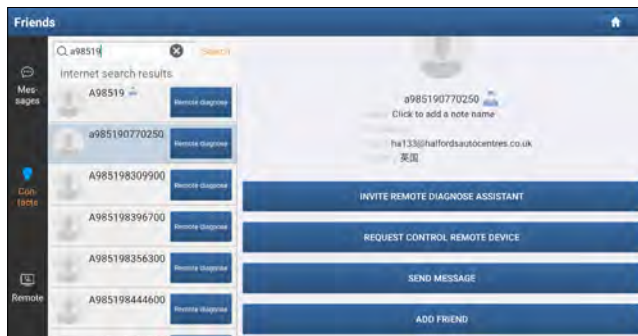

Tap **ADD FRIEND** to send your request.

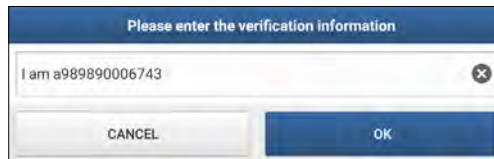

Once the partner receives the request, a beep will sound. Tap the **Messages** tab:

- Once the partner agreed your request, he/she will automatically be listed in the **Contacts** tab.
- If a technician sent you a friend request, you can tap **Agree** to confirm and his/her name will appear in the friend list (Contacts). Or tap **Ignore** to ignore this request.



### 12.1.3 Start Instant Messaging

 Note: The I/M (Instant Messaging) function is open to all users who had Launch's diagnostic tool equipped with this module.

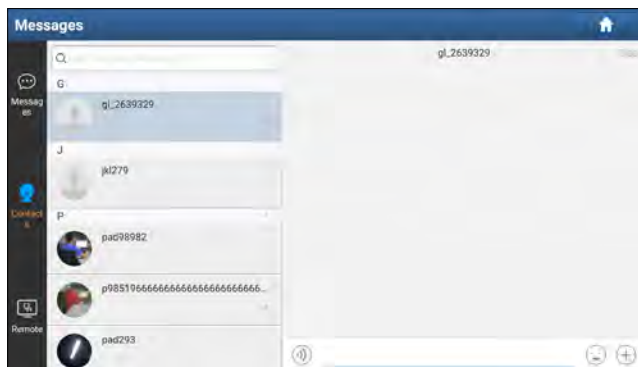
After adding your friends, tap the desired one's photo to enter the following screen:



Tap the input field and use the on-screen keyboard to enter the text message, and then tap **Send** to send it.

- Tap  to send the voice message.
- Tap  to send the emoji.

- Tap **+** to call out more function options.
- Tap **Clear** to delete all the partner's dialog logs.

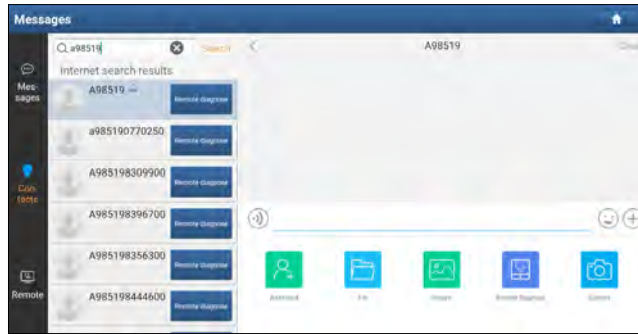

**File:** Choose diagnostic reports or local files to send.

**Picture:** Choose screenshots or pictures to send.

**Remote Diagnostic:** To start a remote diagnostic session. For details, refer to Chapter 12.1.4.

**Camera:** Open camera to take pictures.

### 12.1.4 Launch Remote Diagnosis (Device-To-Device)

The tablet is allowed to initiate remote diagnosis with other diagnostic tools (including but not limited to the X-431 PAD VII) of Launch family, which are equipped with this module.



**Notes:** Before performing this operation, please make sure the following no matter which side sends the remote request:



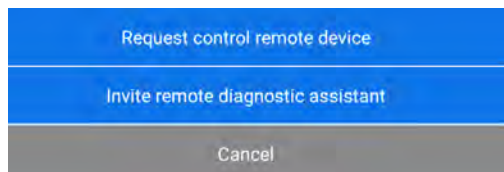

- Turn on the vehicle power supply.
- Throttle should be in a closed position.
- The SmartLink C should be properly connected to the vehicle's DLC and a successful communication between the SmartLink C device and the tablet is required.

Tap **Remote Diagnostic**, the following pull-down menu will pop up on the screen:



These options are defined as follows:

Actions	Results
---------	---------

<p>Request control remote device</p>	<p>Request to control the partner's device remotely to help him diagnose the vehicle.</p> <p> Notes:</p> <ul style="list-style-type: none"> <li>• Remote diagnosis has the same diagnostic steps as manual diagnosis.</li> <li>• In process of remote diagnosis, tap the  button to send a voice message.</li> <li>• Once vehicle diagnosis is complete, a report will be created. Input your comments on this report, and then tap <b>Send Report</b> to send it to the partner.</li> <li>• If you have a local vehicle diagnosis in process, please exit it first before starting remote diagnosis.</li> </ul> <pre> graph TD     A[Tap "Request control remote device"] --&gt; B[Wait for partner's confirmation]     B --&gt; C[Start connecting after request confirmed]     C --&gt; D[Start Diagnosis]     D --&gt; E[Generate diagnostic report]             </pre>
<p>Invite remote diagnostic assistant</p>	<p>If you need support, just use this option to invite a technician to perform a remote control on your tool.</p> <p> Notes:</p> <ul style="list-style-type: none"> <li>• Remote diagnosis has the same diagnostic steps as manual diagnosis.</li> <li>• In process of remote diagnosis, tap the  button to send voice message.</li> <li>• Once you received the report from the partner, tap <b>View Report</b> to view details. All diagnostic reports are saved <b>User Info -&gt; My Report -&gt; Remote Reports</b>.</li> </ul> <pre> graph TD     A[Tap "Invite remote diagnostic assistant"] --&gt; B[Choose the desired diagnostic software]     B --&gt; C[Wait for partner's confirmation]     C --&gt; D[Start connecting after request confirmed]     D --&gt; E[Start Diagnosis]     E --&gt; F[Generate diagnostic report]             </pre>
<p>Cancel</p>	<p>To cancel this operation.</p>

### 12.1.5 Launch Remote Diagnosis (Device-To-PC)

Except that the remote diagnosis can be done between different Launch’s diagnostic tools that come loaded with the module, user also can ask for remote control from PC client technician.

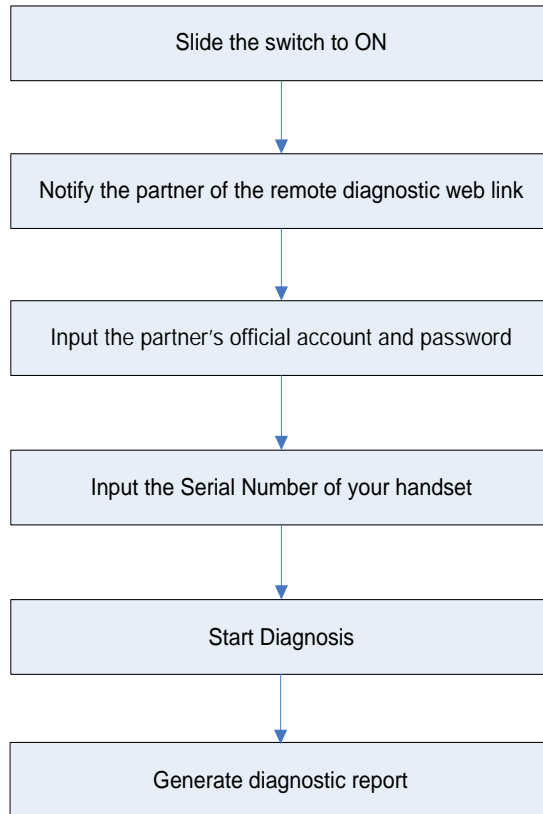

Tap the **Remote** tab, the screen displays as follows:

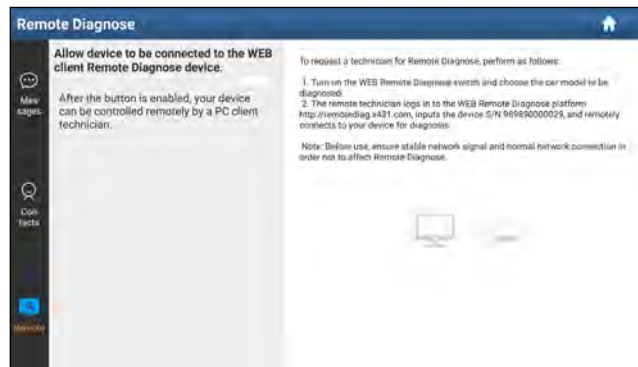

1. Slide the switch **Allow device to be connected to the WEB client remote diagnostic device** to ON so that the partner can find and connect to this device while using the PC.
2. Notify the partner of the PC client website <http://remote.x431.com/cn/>. When the partner accesses the link, the PC displays as below:

---

 Note: Before processing remote diagnosis, please make sure the tablet is properly connected to the vehicle.

---

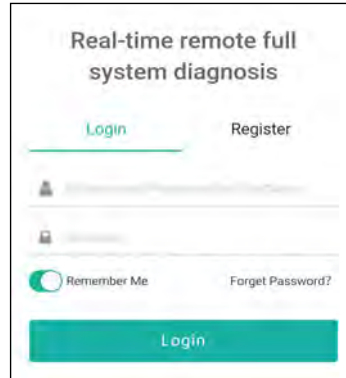

3. Tell the partner to input his own official technician account and password, and then tap **Login** to navigate to the following figure.

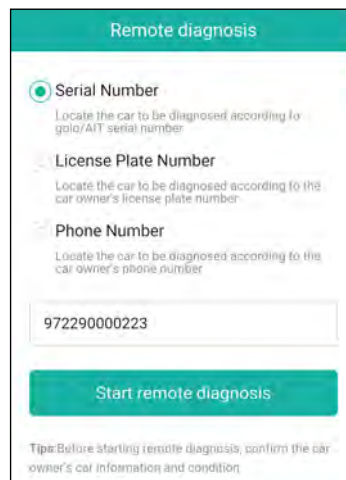

4. Tell the partner to check the box **Serial number** and enter the Serial Number provided by you, and then tap **Start remote diagnosis** to control your device remotely.

In process of remote diagnosis, please note the following things:

- 1) You are not suggested to execute any actions.
- 2) The partner is not allowed to save any diagnostic reports or records on your tablet.

The operations in remote diagnosis are same as those in **Local Diagnose**. Once the session is complete, a remote diagnostic report will be automatically generated.

## 12.2 Toolbox

This function includes the following add-on modules: Oscilloscope, Ignition, Sensor, Multimeter, Battery Tester and Videoscope.

Each module consists of two parts: hardware and app. These modules cannot work properly on the tablet, which need to work with the specific compatible hardware (sold separately). For detailed operations, refer to the User Manual of each module.

## 12.3 Tablet Setting

This module provides a quick dial to the Android's system settings. Alternatively, it also can be accessed by tapping the **Settings** on the Android home screen.

## 12.4 Files

ES File Explorer is a file and application manager. You can access and create folders on the tablet without needing to connect it to a computer.

The app also features an application manager, task killer and download manager. Another excellent feature is support for cloud storage accounts. This means you can download files directly to the folders you want



without using a separate app.

The app has built-in ZIP and RAR sources, so you can access compressed files without unpacking them on your computer first.

For more information, please refer to the associated ES file explorer documents.

You can transfer media files, screenshots and APK between the PC and tablet.

1. On the Home screen, go to **System -> USB Management**, turn off the USB switch to activate the Type C interface.



2. Connect one end of the included data cable to the Type C port of the tablet, and the other end to the USB port of the PC.
3. Swipe the tablet screen from the top, a pull-down option list will appear on the screen.



4. Tap Android System, the following setting options will be displayed on the screen.



5. Select the checkbox **File Transfer** under the **Use USB for** tab.
6. Now you can transfer files between the tablet and PC.

## 12.5 Wireless Upgrade

An Over-the-Air (OTA) update is the wireless delivery of new operating system, software or data to tablets and mobile phones. Wireless carriers have traditionally used over-the-air updates to deploy firmware and configure phones or tablets for use on their network. The initialization of a newly purchased tablet required an over-the-air update.

 Note: While performing OTA update, please make sure the tablet battery has at least 70% and DO NOT run any other programs during the update.

1. On the Job menu, tap **Other modules -> Built-in apps -> Wireless Upgrade.**





2. Tap **Check for updates.** Once a newer version is found, follow the on-screen instructions to download and install the update file.
3. Be patient to wait until the update is done.

## 12.6 TeamViewer QS

This function enables you to receive remote support from technician fellows, colleagues or friends by allowing them to control your tablet on their computer view TeamViewer software.

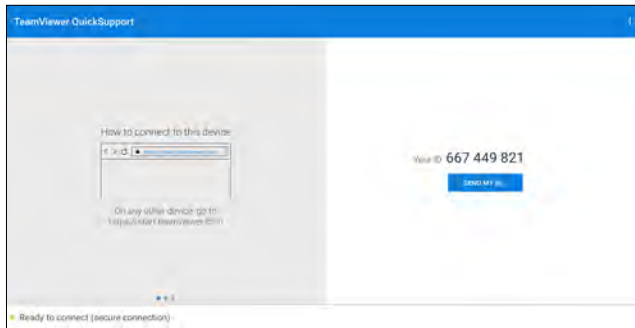
On the Job menu, tap **Other modules -> Built-in apps -> TeamViewer QS.** The following screen will appear:



 Note: In order to provide support and take control of your tablet remotely, you partner needs to install and run the TeamViewer full version program in his computer, and have your TeamViewer ID. Visit <http://www.teamviewer.com> for details.

## 12.7 Recording Master

This module is a free and convenient application that allows you to take tablet screen video capture of high quality, with or without sound.

## 12.8 Browser

This browser is a free cross-platform web browser. It has gained popularity worldwide, featuring tools such as file downloads, password settings, and bookmarks. Users can load several web pages or use a search engine to find any topic on the internet.

## 12.9 Camera

This application allows you to take pictures or record videos with the device camera.

## 12.10 Gallery

This function allows you to take new pictures and manage the picture library (including screenshots).

## 12.11 Video Player

This video player is a media player said to be the best ever created since it supports all types of video formats.

It offers excellent features and video quality. It has great gesture controls, making video playback experience effortless and enjoyable. For instance, you can pinch to zoom, scroll for brightness and volume on respective sides, move out the video on the home screen, and can do much more.

## 12.12 E-Mail

It is an easy-to-use email app that saves you time and keeps your messages safe. Get your emails instantly via push notifications, read and respond online & offline, and find any email quickly.

## 12.13 Calculator

It is a simple-to-use and responsive app. All calculations are made on-the-fly as you input new data.

## 13 J2534 Reprogramming Using SmartLink C

Flash programming has become a common and profitable procedure in the repair and service of today's vehicles. As part of the 21st Century Tune-up, reprogramming is often the only solution for problems ranging from drivability and loss of power to poor fuel economy and emissions related issues. SmartLink C makes it easy. The SmartLink C is a communication interface designed to support J2534 specifications for ECU reprogramming.

### 13.1 As a Local J2534 PassThru Device

Except that the SmartLink C acts as a VCI device and a SmartLink dongle, it also can be used as a J2534 PassThru device, working together with the PC installed with the OEM diagnostic software to perform the J2534 reprogramming. In this case, the PC needs to install with the LAUNCH's J2534 tool, which can be downloaded from [www.cnlaunch.com](http://www.cnlaunch.com).

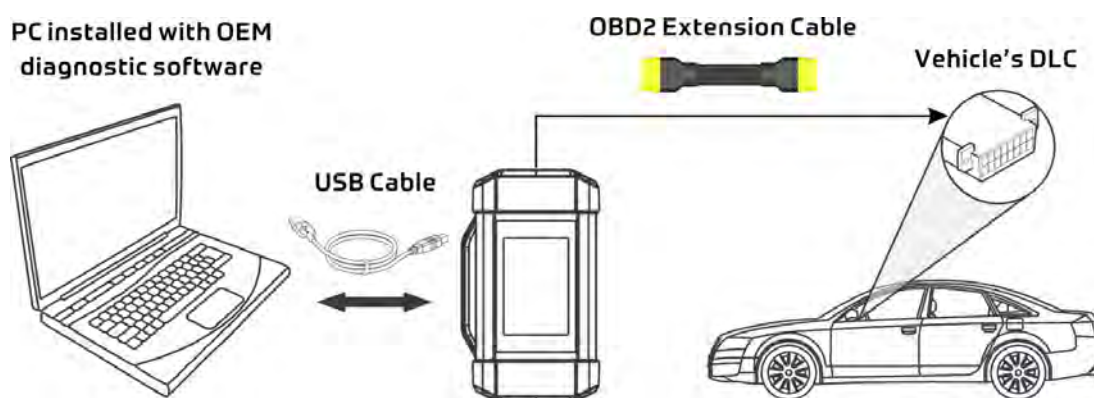

### 13.2 As a Remote J2534 PassThru Device

Besides local ECU reprogramming, remote ECU reprogramming function is also supported using SmartLink C.

\*Before diagnosing, please make sure the following conditions are met:

- The SmartLink C device is connected to the Internet and has a strong network signal.
- The OEM diagnostic software has been installed on the PC.
- The LAUNCH's J2534 tool has been installed on the PC. This tool and its associated operation instruction documentation can be downloaded from [www.cnlaunch.com](http://www.cnlaunch.com).

Ensure that the remote reprogramming operation is performed after the SmartLink C is connected to the vehicle's DLC port and the Internet, and has been switched to the super remote diagnosis mode. For specific operations, please refer to other associated documentation.

PC installed with OEM diagnostic software



Vehicle's DLC

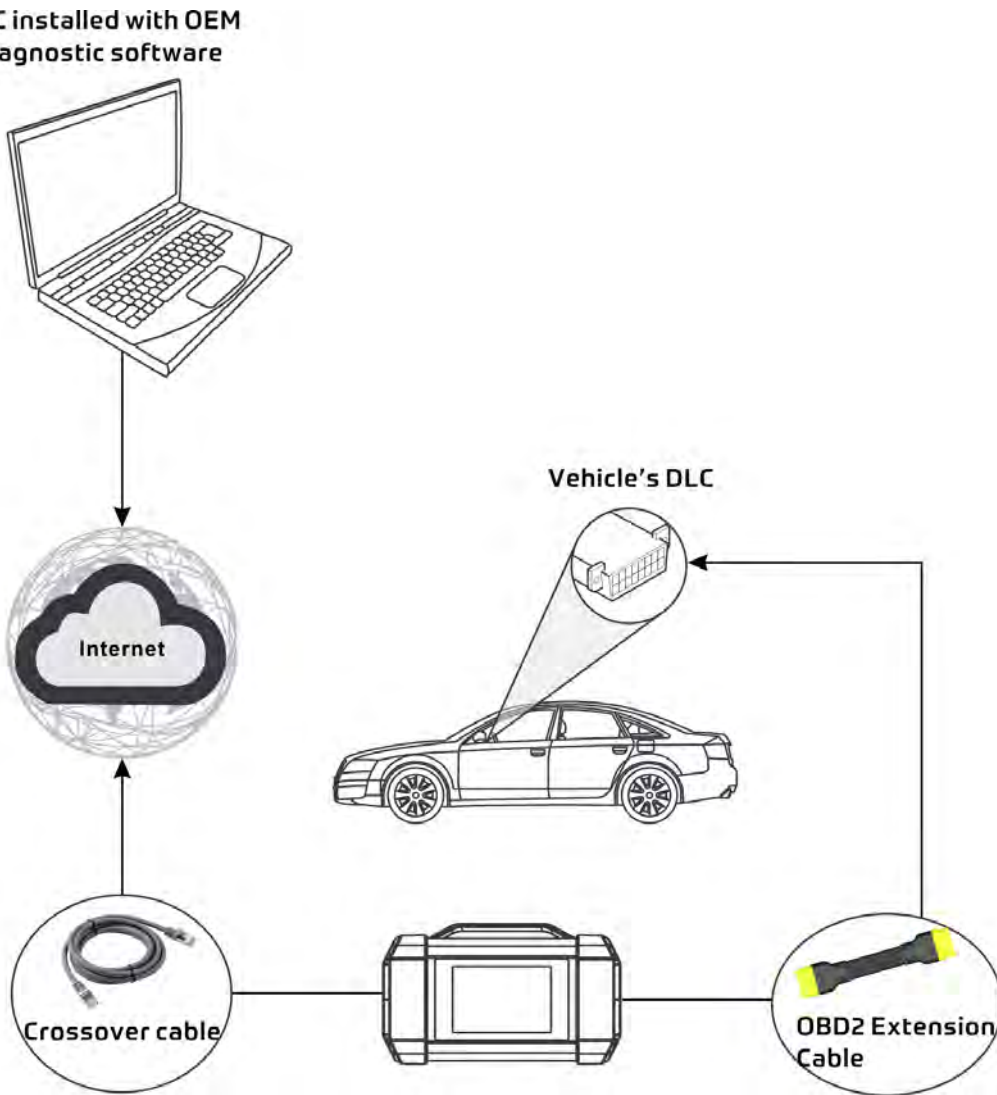
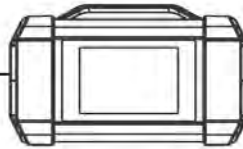

## 14 FAQ

### 14.1 About X-431 PAD VII

#### 1. How to save power?

- Please turn off the screen while the tool keeps idle.
- Set a shorter standby time.
- Decrease the brightness of the screen.
- If WLAN connection is not required, please turn it off.

#### 2. Communication error with vehicle ECU?

Please confirm:

1. Whether the SmartLink C device is correctly connected.
2. Whether ignition switch is ON.
3. If all checks are normal, send vehicle year, make, model and VIN number to us using Feedback feature.

#### 3. Failed to enter into vehicle ECU system?

Please confirm:

1. Whether the vehicle is equipped with this system.
2. Whether the SmartLink C device is correctly connected.
3. Whether ignition switch is ON.
4. If all checks are normal, send vehicle year, make, model and VIN number to us using Feedback feature.

#### 4. How to reset the tablet?

Resetting may cause data loss. Before doing so, please make sure important data and information has been backed up.

Do the following to reset the tablet:

1. Tap **Settings -> System -> Reset options**.
2. Tap **Erase all data (factory reset)**.
3. Tap **RESET TABLET**.
4. Tap **ERASE EVERYTHING** to start resetting until the tool automatically reboots.

#### 5. How to download the X-431 PAD VII App after resetting the tablet?

 Note: Before registration, please make sure the network is properly connected.

After the tablet has been successfully reset, follow the steps below to download the App:

1. Launch the browser and the default official Launch website opens (If a blank page pops up, just type in [www.x431.com](http://www.x431.com) in the input bar).
2. Tap **Login**, input the username and password and tap **Log In**.
3. Make sure that the serial number is correct, tap APP application program and tap the Download icon to start downloading.
4. After the download is complete, follow the on-screen instructions to install it.
5. After installation, use the existing username and password to login and go to update center to download the diagnostic software.

#### 6. What to do if the language of vehicle diagnostic software does not match the system language?

English is the default system language of the tool. After the system language is set to the preference language, please go to the update center to download the vehicle diagnostic software of the corresponding language.

If the downloaded diagnostic software is still displayed in English, it indicates that the software of the current language is under development.

**7. How to retrieve the login password?**

Please follow below steps to proceed in case you forgot the login password:

1. Tap the application icon on the home screen to launch it.
2. Tap the **Login** button on the upper right corner of the screen.
3. Tap **Retrieve password**.
4. Input product S/N and follow the on-screen prompts to retrieve the password.

**8. How to back up data?**

1. Turn the tablet on.
2. Plug the external storage device into the Type A port (not type-C port) of the tablet.
3. After the tablet identifies the storage device, USBxxxx will appear under the Internal Storage.

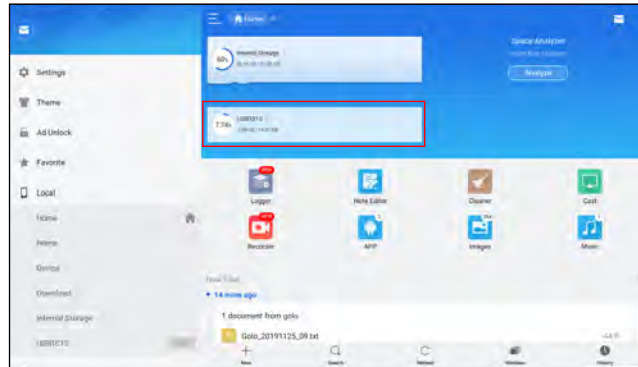

4. Tap **Internal Storage** (Note: Take *Pictures* for example).

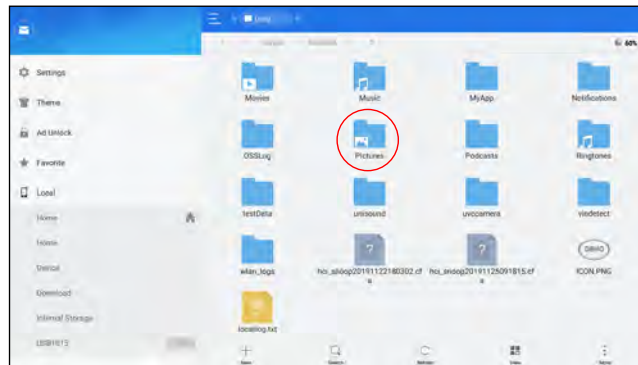

5. To copy all files in the **Screenshots** folder, tap on it for a while, all available operation options will appear.





6. Tap **Copy** on the bottom of the screen, the folder is successfully copied.
7. Tap USBxxxx and select the target folder, tap **Paste** to start copying.

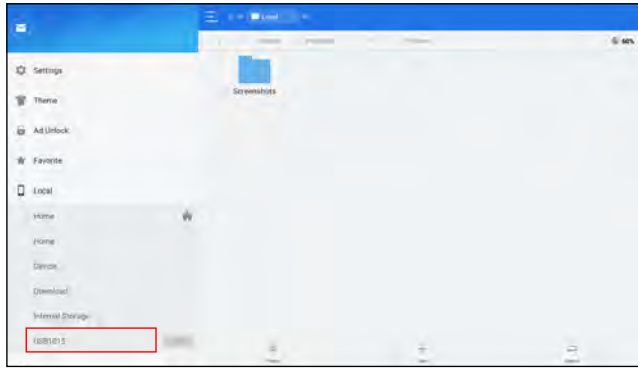

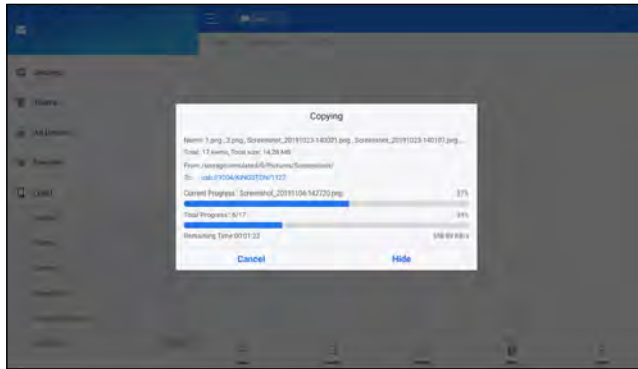

8. After the total progress reaches to 100%, the backup is OK. Unplug the storage device from the tablet.



 Note: Another method is available for picture backup. User also can go to Gallery to select the desired folder/files and share it to the external storage device via **ES Save to....**

## 14.2 About SmartLink Diag.

### 1. What network condition is required for SmartLink Diag.?

The remote SmartLink Diag. operation requires a network broadband of 100 MB or above.

### 2. What does the word “Delay” displayed on the SmartLink C screen mean?

The Delay (network delay) indicates the quality of the current network. Different colors represent different delay status. There are three states of network delay:

- Green: Indicates the network is normal. It is recommended that the diagnosis operation be performed when the network delay is green. Otherwise, the communication with the vehicle may fail or the incorrect system detection may occur.
- Yellow: Indicates the network is not stable. Please keep it stable.
- Red: Indicates the network delay is serious and not suitable for remote diagnosis or the network is disconnected.

### 3. Why is the network connection so poor?

If the displayed network is poor, there may be too many people using the network in the LAN and some users are downloading. It is recommended to use a stable network for remote SmartLink diagnosis.

### 4. Why does the sign appear on the upper right corner of the SmartLink C screen?

Some networks have firewall restriction which leads to a longer delay of connection. You are most likely to see this sign while your system is in connection with networks managed by communities or companies. It is recommended to use the networks directly installed by telecommunication operators where there is no firewall restriction.

### 5. Some systems of some old vehicles cannot be tested.

The SmartLink C device supports CANBUS and DoIP communication protocols, but some old vehicle uses K-Line communication protocol.

**6. Is it necessary to re-ignite the car after the diagnostic system starts working?**

For the sake of some vehicle's conditions, the re-ignition will provide you a more detailed analysis after OBD diagnosis.

**7. Can I charge the SmartLink C device through an external DC power supply?**

No. The SmartLink C device obtains power only through a vehicle's OBD diagnostic socket. Getting power through an external DC power supply could result in system malfunction.

**8. How to update SmartLink C system?**

After the SmartLink C device is powered on and connected to the network, a message "Whether to upgrade now?" will be displayed if a new system version is detected. Tap **Yes** to start updating, wait until the upgrade is complete.

## 15 Glossary of Terms & Abbreviations

**ABS** – Anti-Lock Brake System

**AC** – Alternative Current

**ADAS** -- Advanced Driver Assistance Systems

**AFS** – Adaptive Front-lighting System

**CAN** – Controller Area Network

**Communication Protocol** – Allows different systems and sensors in a vehicle to communicate.

There are currently five Protocols:

- CAN Bus
- J1850 VPW
- ISO 9141-2
- J1850 PWM
- ISO 14230 KWP

**DC** – Direct Current

**DLC** – Data Link Connector

The 16-cavity connector on the vehicle that allows communication between the computer system and the diagnostic tool.

**DPF** – Diesel Particulate Filter

**DTC** – Diagnostic Trouble Code

A code stored in the computer system's memory, which helps to identify the fault condition that is causing the MIL to activate.

**Drive Cycle** – A set of driving procedures that, when met, provide the Enabling Criteria for the I/M Monitors to run and complete their diagnostic tests.

**Freeze Frame Data** – A digital representation of engine and/or emissions system conditions present when a fault code was recorded.

**Generic Code** – A DTC that applies to all OBD2 compliant vehicles.

**I/M** – Instant Messaging

**I/M Readiness** – An indication of whether or not a vehicle's emissions-related system are operating properly and are ready for Inspection and Maintenance testing.

**LCD** – Liquid Crystal Display

**LED** – Light Emitting Diode

**Manufacturer Specific Code** – A DTC that applies only to OBD II-compliant vehicles made by a specific manufacturer.

**MIL** – Malfunction Indicator Lamp

The vehicle's "Check Engine" warning light that activates when a DTC is stored.

**OBD I** – On-Board Diagnostics Version 1

**OBD II** – On-Board Diagnostics Version 2

**OEM** – Original Equipment Manufacturer

**PID** – Parameter Identification Data

Data returned by the vehicle's Control Modules to the diagnostic tool.

**TPMS** – Tire Pressure Monitor System

**VCI** – Vehicle Communication Interface

**WLAN** – Wireless Local Area Network

### **Warranty**

THIS WARRANTY IS EXPRESSLY LIMITED TO PERSONS WHO PURCHASE LAUNCH PRODUCTS FOR PURPOSES OF RESALE OR USE IN THE ORDINARY COURSE OF THE BUYER'S BUSINESS.

LAUNCH electronic product is warranted against defects in materials and workmanship for one year (12 months) from date of delivery to the user.

This warranty does not cover any part that has been abused, altered, used for a purpose other than for which it was intended, or used in a manner inconsistent with instructions regarding use. The exclusive remedy for any automotive meter found to be defective is repair or replacement, and LAUNCH shall not be liable for any consequential or incidental damages.

Final determination of defects shall be made by LAUNCH in accordance with procedures established by LAUNCH. No agent, employee, or representative of LAUNCH has any authority to bind LAUNCH to any affirmation, representation, or warranty concerning LAUNCH automotive meters, except as stated herein.

### **Order Information**

Replaceable and optional parts can be ordered directly from your LAUNCH authorized tool supplier. Your order should include the following information:

1. Quantity
2. Part number
3. Item description

### **Customer Service**

If you have any questions on the operation of the unit, please contact local dealer, or contact **LAUNCH TECH. CO., LTD.:**

Website: [www.x431.com](http://www.x431.com)

[www.cnlaunch.com](http://www.cnlaunch.com)

Phone: +86 755 8455 7891

Email: [overseas.service@cnlaunch.com](mailto:overseas.service@cnlaunch.com)

**Statement:** LAUNCH reserves the rights to make any change to this manual without notice. We have tried our best to make the descriptions and illustrations in the manual as accurate as possible, and defects are inevitable, if you have any question, please contact local dealer or LAUNCH TECH. CO., LTD., LAUNCH does not bear any responsibility arising from misunderstandings.

## **FCC Statement**

This equipment has been tested and found to comply with the limits for a Class B digital device, pursuant to part 15 of the FCC rules. These limits are designed to provide reasonable protection against harmful interference in a residential installation.

This equipment generates, uses and can radiate radio frequency energy and, if not installed and used in accordance with the instructions, may cause harmful interference

to radio communications. However, there is no guarantee that interference will not occur in a particular installation. If this equipment does cause harmful interference to

radio or television reception, which can be determined by turning the equipment off and on, the user is encouraged to try to correct the interference by one or more of the

following measures:

-Reorient or relocate the receiving antenna.

-Increase the separation between the equipment and receiver.

-Connect the equipment into an outlet on a circuit different from that to which the receiver is connected.

-Consult the dealer or an experienced radio/TV technician for help.

To assure continued compliance, any changes or modifications not expressly approved by the party.

Responsible for compliance could void the user's authority to operate this equipment. (Example- use only shielded interface cables when connecting to computer or peripheral devices).

This equipment complies with Part 15 of the FCC Rules. Operation is subject to the following two conditions:

(1) This device may not cause harmful interference, and

(2) This device must accept any interference received, including interference that may cause undesired operation.

The SAR limit adopted by USA and Canada is 1.6 watts/kilogram (W/kg) averaged over one gram of tissue. The highest SAR value reported to the Federal Communications Commission (FCC) and the Industry Canada (IC) for this device type when it is tested properly worn on the body is 0.023W/kg.

The device complies with the RF specifications when the device is used near your at a distance of 0 mm from your body. Ensure that the device accessories

such as a device case and a device holster are not composed of metal components. Keep your device 0 mm away from your body to meet the requirement earlier mentioned.

This device was tested for typical body-worn operations. To comply with RF exposure requirements, a minimum separation distance of 0 mm must be maintained between the user's body and the handset, including the antenna. Third-party belt-clips, holsters, and similar accessories used by this device should not contain any metallic components. Body-worn accessories that do not meet these requirements may not comply with RF exposure requirements and should be avoided. Use only the supplied or an approved antenna.