

Copyright

Copyright © 2021 by LAUNCH TECH CO., LTD. All rights reserved. No part of this publication may be reproduced, stored, or transmitted in any form without the written permission of the copyright owner.

Trademark

Launch is a registered trademark of LAUNCH TECH CO., LTD in China and other countries. All other marks are trademarks or registered trademarks of their respective owners.

Disclaimer

The contents of this document are subject to changes without notice due to continued improvements in design, manufacture, and methodologies. Launch is not liable for the damage or losses due to the use of this document.

FCC Statement

Any Changes or modifications not expressly approved by the party responsible for compliance could void the user's authority to operate the equipment.

This device complies with part 15 of the FCC Rules. Operation is subject to the following two conditions:

- a. This device may not cause harmful interference
- b. This device must accept any interference received, including interference that may cause undesired operation.

Note: This equipment has been tested and found to comply with the limits for a Class B digital device, pursuant to part 15 of the FCC Rules. These limits are designed to provide reasonable protection against harmful interference in a residential installation. This equipment generates uses and can radiate radio frequency energy and, if not installed and used in accordance with the instructions, may cause harmful interference to radio communications. However, there is no guarantee that interference will not occur in a particular installation. If this equipment does cause harmful interference to radio or television reception, which can be determined by turning the equipment off and on, the user is encouraged to try to correct the interference by one or more of the following measures:

- Reorient or relocate the receiving antenna.
- Increase the separation between the equipment and receiver.
- Connect the equipment into an outlet on a circuit different from that to which the receiver is connected.





- Consult the dealer or an experienced radio/TV technician for help.

The device has been evaluated to meet general RF exposure requirement. The device can be used in portable exposure condition without restriction.

 Important: Please read this manual carefully and understand the safety precautions before performing any operation to this product.

Safety Grades

Safety grade definitions in this manual are as followings:

Symbol	Definition	Usage
	Danger	Indicates a hazardous situation which, if not avoided, will result in death or serious injury to the operator or to bystanders.
	Warning	Indicates a hazardous situation which, if not avoided, could result in possible injury to the operator or to bystanders.
	Caution	Indicates a hazardous situation which, if not avoided, could result in serious equipment damage or property losses.

Safety Precautions

- Never collide, throw, or puncture the test equipment, and avoid falling, extruding and bending it.
- Do not insert foreign objects into or place heavy objects on your device. Sensitive components inside might cause damage.
- Do not use the test equipment in exceptionally cold or hot, dusty, damp or dry environments.
- In places using the test equipment may cause interference or generate a potential risk, please turn it off.
- The test equipment is a sealed unit. There are no end-user serviceable parts inside. All internal repairs must be done by an authorized repair facility or qualified technician. If there is any inquiry, please contact the dealer.
- Never place the test equipment into apparatus with strong electromagnetic field.



- Do not attempt to replace the internal rechargeable lithium battery. Contact the dealer for factory replacement.
- Use the included battery and charger. Risk of explosion if the battery is replaced with an incorrect type.
- Do not disconnect power abruptly when the test equipment is being formatted or in process of uploading or downloading. Or else it may result in program error.
- Do not disconnect battery or any wiring cables in the vehicle when the ignition switch is on, as this could avoid damage to the sensors or the ECU.
- Do not place any magnetic objects near the ECU. Disconnect the power supply to the ECU before performing any welding operations on the vehicle.
- Use extreme caution when performing any operations near the ECU or sensors. Ground yourself when you disassemble PROM, otherwise ECU and sensors can be damaged by static electricity.
- When reconnecting the ECU harness connector, be sure it is attached firmly, otherwise electronic elements, such as ICs inside the ECU, can be damaged.

Packing List

The following packing list is for reference purpose only. For different destinations, the accessories may vary. For details, please consult from the local dealer or check the packing list supplied with this tool together.

- Main unit
- Power adaptor
- Main diagnostic cable
- The fourth-generation data acquisition cable
- The fourth-generation of EEPROM data acquisition cable(without dismantling dashboard)
- BENCH mode cable
- MCU converter V1
- MCU converter V2
- MCU cable with multiple leads
- EEPROM chip adaptor
- Benz infrared analog acquisition key



- MCU cable with multiple leads
- EEPROM converter
- User Manual

Table of Contents

1 About this Manual	1
1.1 Target Reader	1
1.2 Typographic Conventions	1
1.3 Symbols	1
2 About X-PROG 3	2
2.1 Product Overview	2
2.2 Power Source	3
2.3 Technical specifications	4
2.4 Accessories	4
3 Diagnostics	4
3.1 Common Operations	4
3.1.1 Establish Hardware Connection	4
3.1.2 Establish Wireless Connection	5
3.1.3 Perform Common Operations	6
3.2 Diagnostic Operations	7
3.2.1 Key Programming	7
3.2.2 Gear Box Programming	12
3.2.3 Engine Programming	17
3.2.4 Return from Diagnostic Function	26
4. Software Upgrade	26
5. Warranty	27



1 About this Manual

This manual introduces the basic information of X-PROG 3 and instruction on the product usage. X-PROG 3 is a powerful anti-theft solution and an ideal choice for professional repair shops and vehicle maintenance businesses. It has achieved vehicle key, Engine and gearbox programming, featuring powerful multiple parts reprogramming and wide range of vehicle coverage.

1.1 Target Reader

This document is intended for vehicle owners or repair technicians to perform various diagnostic procedures using X-PROG 3; it assumes a basic knowledge of vehicles.



1.2 Typographic Conventions

The typographic elements that may be found in the document are defined in the following table:

Item	Presentation	Example
Cascading Menus	->	X431->Local Diagnosis
Parameter/value	Bold	Slide the WLAN switch to “ON” .
Variable/unfamiliar term	<i>Italic</i>	Visit us by <i>http://cnlaunch.com</i> .
UI control	Bold	On the Health Check screen, tap Enter .
Message	“”	The “success” message appears.

1.3 Symbols

Following symbols are used in this document:

Symbol	Definition	Usage
	Note	Widely used for any supplementary information.
	Tip	Refers to easily overlooked tricks that is necessary for a better user experience.

2 About X-PROG 3

2.1 Product Overview

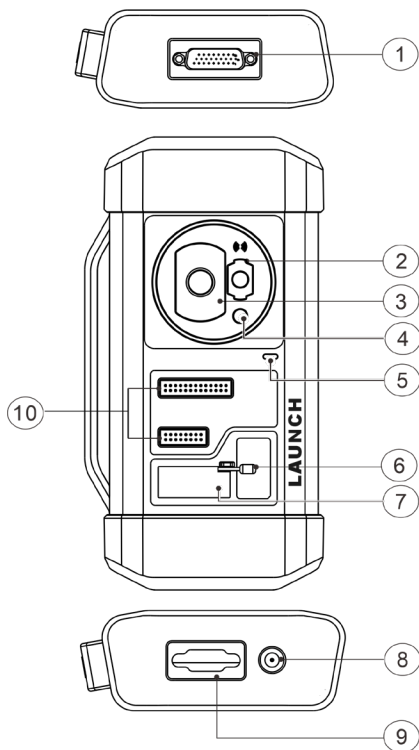

No.	Part Name	Description
1	DB26 diagnostic connector	To connect with all anti-theft cables.
2	Benz key slot	To place Benz car key.
3	Key slot	To place car key for RF defection.
4	Key chip slot	To place key chip.
5	Power indicator	<ul style="list-style-type: none"> • Red light indicates faults. • Orange light indicates functions normally.
6	Valve	To tighten loose EEPROM board.
7	EEPROM slot	To insert EEPROM board
8	Power port	For power charging
9	DB15 diagnostic connector	To connect with main diagnostic cable.
10	DIY slot	To insert vehicle DIY board.

2.2 Technical specifications





Input voltage	12 V DC
Input current	500 mA
Working temperature	0 to 50 °C
Storage temperature	- 20 to 70 °C
Dimension	39 x 107 x 298 mm





2.3 Power Source

The product does not have an independent power supply, you can power it up via either of the followings ways:

- Use the included power adaptor
- Connect the device through the vehicle's DLC

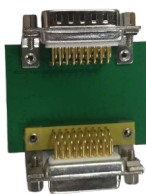
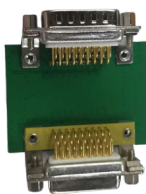
2.4 Accessories

Photo	Accessory Name	Description
	Main Diagnostic Cable	To connect vehicle DLC port, VCI and programmer for diagnose.
	Power adaptor	To provide power supply for the programmer.
	The fourth-generation data acquisition cable	After removing the vehicle dashboard, connect programmer, vehicle dashboard, and the cable.
	The fourth generation of EEPROM data acquisition cable (without dismantling dashboard)	Connect the programmer and vehicle dashboard, and then place the probe (the yellow lead) to the designated area.

	<p>BENCH mode cable</p>	<p>Connect the programmer and the engine to read engine or gearbox ECU (Connect engine ECU with the BENCH mode cable based on BENCH mode diagram).</p>
	<p>MCU Converter V1</p>	<p>Connect the programmer with MCU(chip soldering is required in this procedure).</p>
	<p>MCU Converter V2</p>	<p>Connect the programmer with MCU(chip soldering is required in this procedure).</p>
	<p>EEPROM chip adaptor</p>	<p>Place the EEPROM chip onto the adaptor, and then plug it into the programmer socket.</p>
	<p>Benz infrared analog acquisition key</p>	<p>To connect the programmer with the key lock, insert the key into the programmer for further key operations.</p>
	<p>EEPROM converter</p>	<p>Solder the desired chip on the EEPROM converter, and then plug the board into the programmer(chip soldering is required)</p>



MCU cable with
multiple leads

To connect the programmer
and MCU.

3 Diagnostics



X-PROG 3 diagnostic function supports key programming, engine and gearbox replacement for various of vehicles, you can retrieve ECU information, read, erase, and write in for a range of chips as shown in the product options.

3.1 Common Operations

• 3.1.1 Establish Hardware Connection

You need to turn off the ignition and correctly locate the vehicle Data Link Connector (DLC) so as to perform hardware connection.

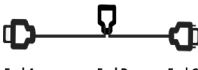
You can refer to the table below for hardware connection:

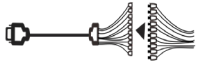
User Scenario	Cable Image	End A	End B	End C
Key programming	 <p>End A End B End C</p> <p>Main diagnostic cable</p>	Connect with Launch VCI connector for data transmission	Connect with vehicle's DLC	Connect with X-PROG 3
Engine/ Gearbox programming	 <p>End A End B End C</p> <p>Power cable</p>	Connect power supply	N/A	Connect with end B the main diagnostic cable
Engine/ Gearbox programming	 <p>End A End B</p> <p>MCU cable with multiple leads</p>	Connect with X-PROG 3	Connect with the engine or gearbox to be repaired/replaced	N/A

Engine/ Gearbox programming	 <p>End A End B End C</p> <p>Main diagnostic cable</p>	Connect with Launch VCI connector for data transmission	Connect power supply cable	Connect with X-PROG 3
-----------------------------------	---	---	-------------------------------------	--------------------------

• 3.1.2 Establish Wireless Connection

You must make sure that your diagnostic tool is well connected with X-PROG 3, follow steps below to check wireless connection:

 **Note:** It is strongly recommended to connect the diagnostic tool with the VCI connector using a USB cable for effective data transmission.

1. Slide down the status bar from the top.
2. Touch , go to **Wireless and network -> Bluetooth**.
3. Select the X-PROG 3 to be connected, wait until the connection is successful.

• 3.1.3 Perform Common Operations

You should enter the function interface before using the programmer.

1. Turn on a Launch diagnostic tool, and/or open the diagnostic App on the home screen.
2. On the main diagnostic screen, enter Anti-theft system either from **Local Diagnose** or **Reset**, touch **OK**.



3. You will view the connection diagram, touch **OK**.

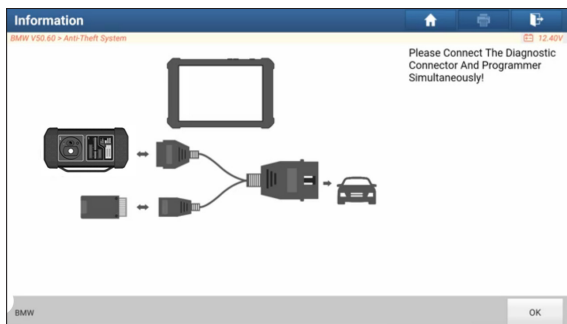

4. Depending on your requirement, touch any of the following options :
- Gearbox Learning
 - Anti-Theft System
 - Engine System

3.2 Diagnostic Operations

• 3.2.1 Key Programming

You can use anti-theft system to access key chip programming functions. The product supports reading, retrieving and writing key information, as well as other key-related functions.

• Connecting diagnostic system

Note:

The USB cable shown in below diagram is not included in the packing list for now, using a USB cable could effectively enhance your data transmission speed.

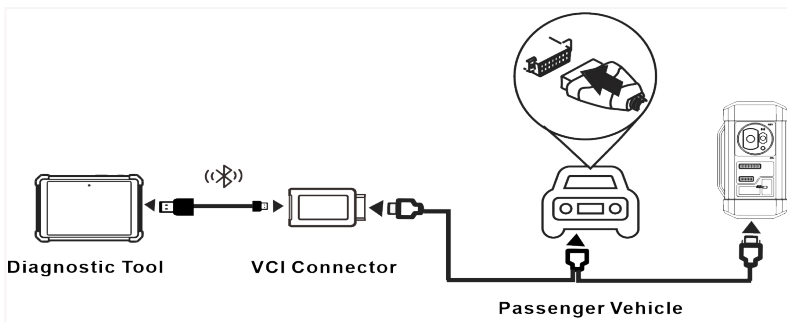

- **Operating on key programming**

You can use key programming function to backup old key data and write in data for new keys. Below procedure shows you how to perform key programming for BMW using Launch diagnostic product, it contains backup current key data and new key generation.

1. Backup current key data.

a. Touch **Intelligent Mode**.

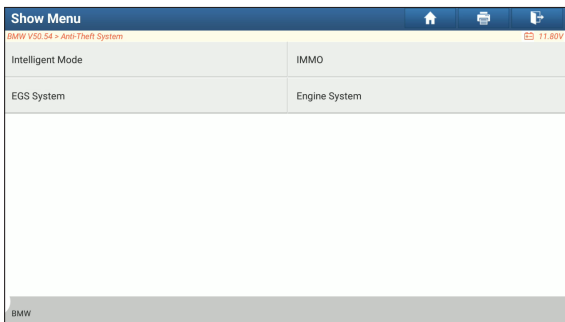

b. Touch **OK** to confirm the IMMO Type.

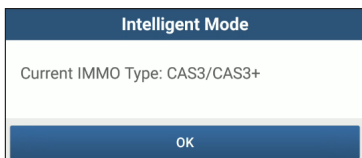

c. Touch **Key Operation**.

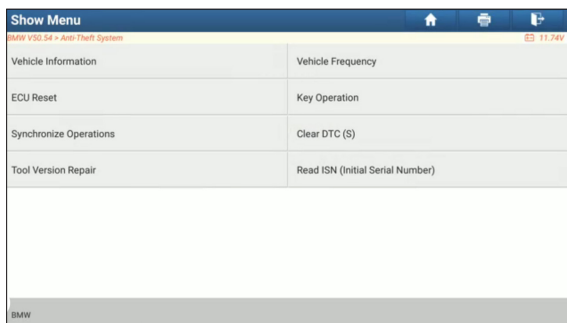

d. Touch **Key Learning**.

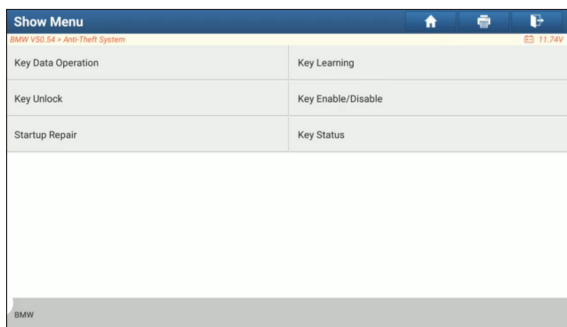

e. Touch **OK** after reading the the onscreen instruction.

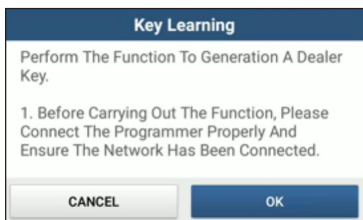

f. Touch **OK**.

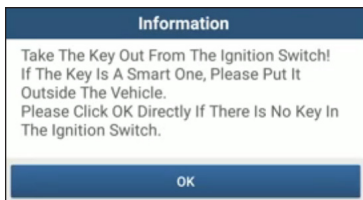

g. Touch **OK** to save the key data.

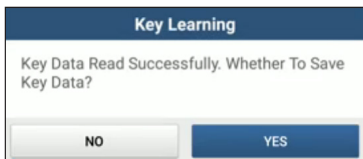

h. Enter the key file name and touch **OK**.

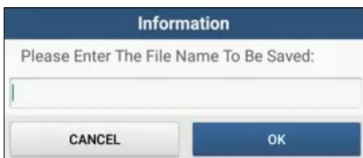

i. Key file saved, touch **OK** to confirm.



2. Generate a new key.

a. Touch the desired blank key position.

Key Learning					
Key Position	Key ID	Key Type	Key Status	Vehicle Information	Enable/Disable Status
Key 2	BB53EE90	PCF 7953 remote key	Used	014B00	Disable
Key 3	1454EE90	PCF 7953 remote key	Used	004B00	Enable
Key 4	47AE9896	PCF 7953 remote key	Used	004300	Enable
Key 5	9CD3869E	PCF 7953 remote key	Used	004300	Enable
Key 6	FFFFFFFF	Unknown	Unused	007608	Enable
Key 7	FFFFFFFF	Unknown	Unused	007608	Enable
Key 8	FFFFFFFF	Unknown	Unused	007608	Enable

Key Generated By Ignition Switch
 Key Generated By Programmer
 Erase Key 1

BMW

b. Place the new key into the programmer key slot and touch **OK**.

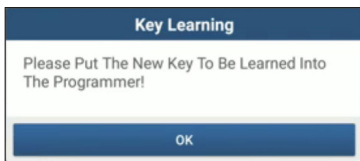

c. Confirm the key type, if you are using a smart key, touch **YES**.



d. If the key generation is done, touch **OK** to confirm.

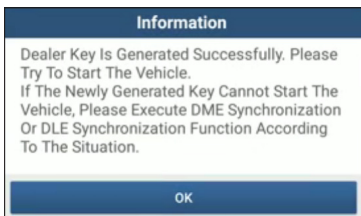

• 3.2.2 Gearbox Programming

You can use gearbox programming function to restore the old gearbox data or write in new data after a new gearbox is replaced.

• Connecting diagnostic system for gearbox programming

 Note:

- The USB cable shown in below diagram is not included in the packing list for now, using a USB cable could effectively enhance your data transmission speed.
- Certain Vehicle gearboxes are connected based on the real chassis type, for information how to connect the gearbox, refer to the *onscreen connection diagram*.

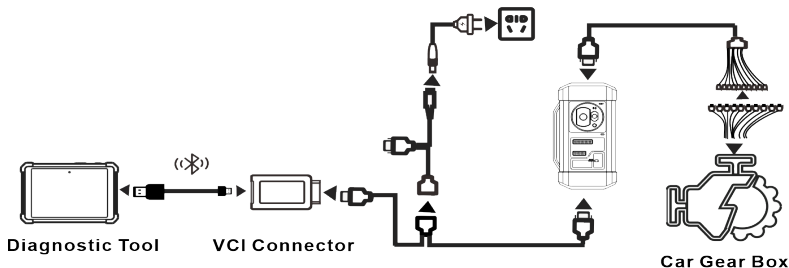

• Operating on gearbox programming

Below procedure shows you how to perform gearbox programming for a BMW using Launch diagnostic product, the procedure contains gearbox connection and erasure of gearbox data.

1. Connecting the gearbox.

- a. On the programmer function interface, touch **EGS System** to enter gearbox programming.

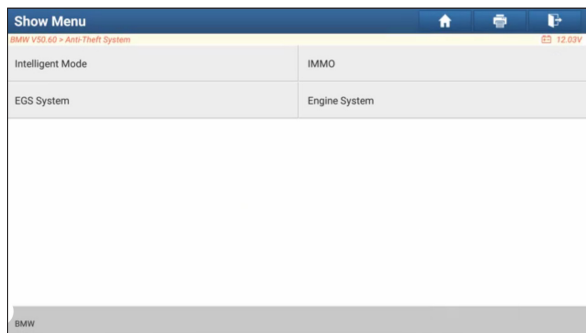

- b. Touch the correct chassis type.

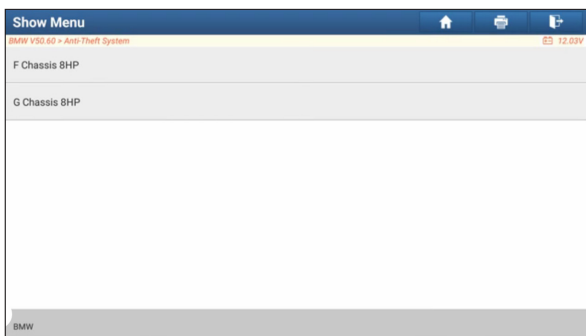

- c. You will then see a corresponding connection diagram. Touch **OK**.

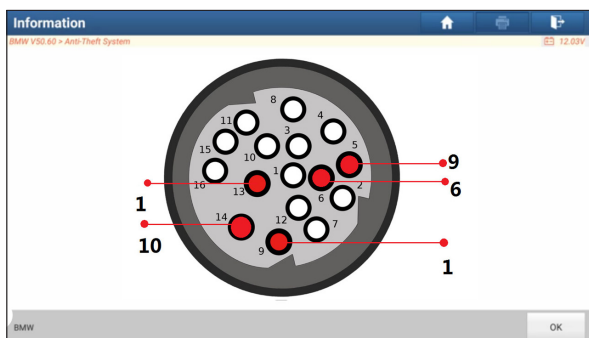

2. Erasing gearbox data.

a. Touch **EGS Erasure**.

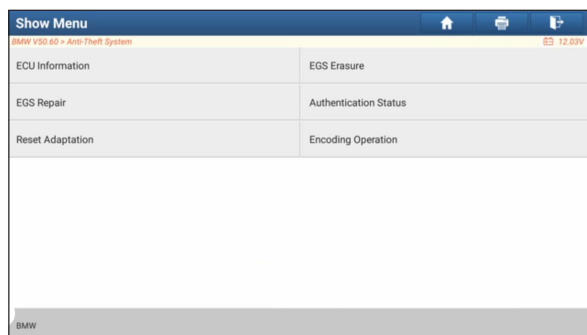

b. Touch **DOWNLOAD**.

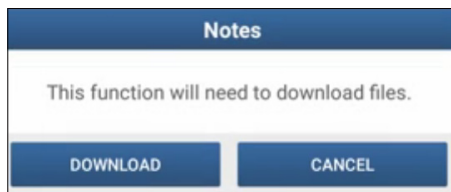

c. Touch **OK**.

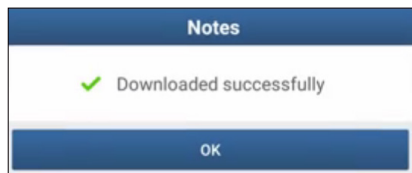

d. Touch **DOWNLOAD**.

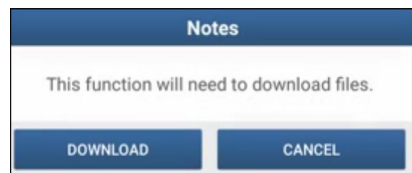

e. Touch **OK**.

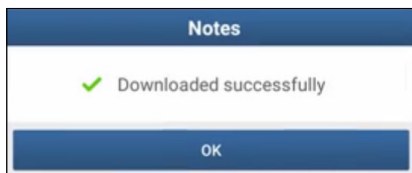

f. Touch **YES**.



g. Touch **YES**.

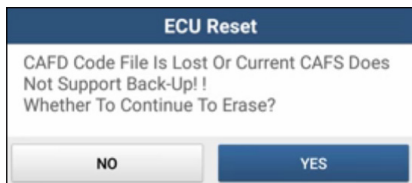

h. Touch **OK**.

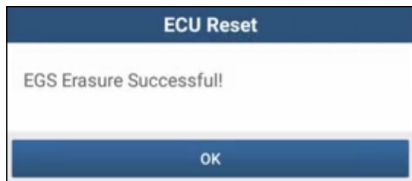

• 3.2.3 Engine Programming

The engine programming function supports engine data reading, after a new gearbox is replaced, you can use engine programming function to write in the backup data.

• Connecting diagnostic system for Engine programming

Note:

- The USB cable shown in below diagram is not included in the packing list for now, using a USB cable could effectively enhance your data transmission speed.
- Vehicle engine connection could vary depending on engine types, for information how to connect the car engine, refer to the onscreen connection diagram.

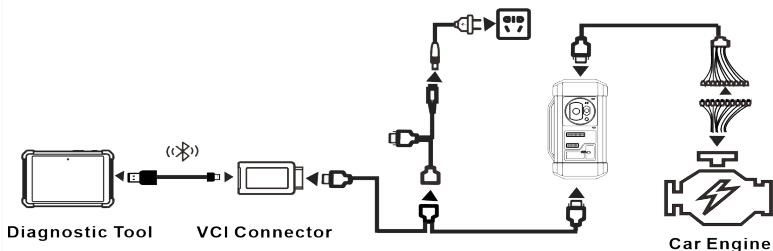

• Operating on Engine Programming

Below procedure shows you how to perform engine programming for a Volkswagen using Launch diagnostic product, the procedure contains chip ID

retrieval, engine connection, data backup and data restoration.

1. Retrieve chip ID.

a. Touch **Engine**.

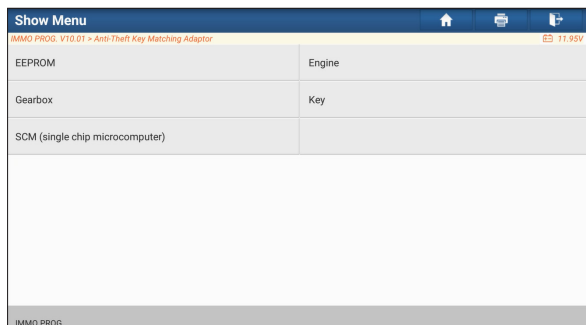

b. Select Engine Brand.

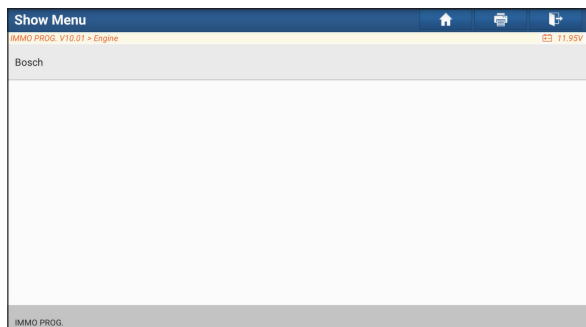

c. Touch **Search for ECU model**.



- d. Check ECU model (printed on the sticker on the back of your Engine), enter the engine type in the dialogue box(In example below,the engine type should be MED17.7.7).

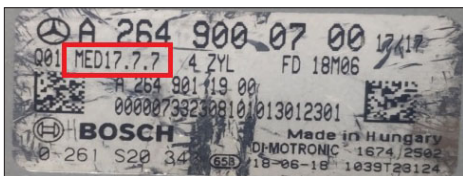

Information

Input engine type (such as MED17.1)

CANCEL

OK

- e. Touch **OK**.

Information

The main control chip corresponding to the current engine type is: TC1793

OK

2. Connect the engine.
 - a. Touch View Wiring Diagram.

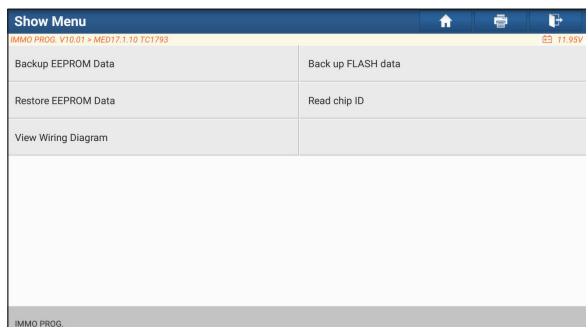

- b. Read the connection diagram, perform the proper connection based on the engine type and then touch **OK**.

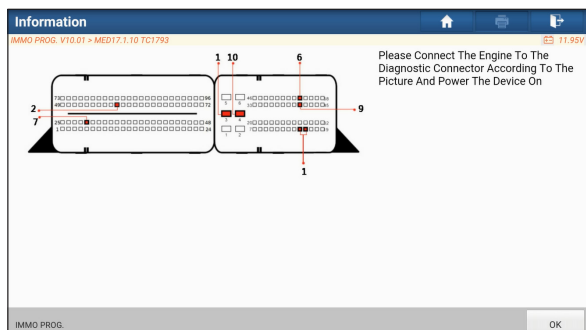

- c. Touch **Read chip ID**.

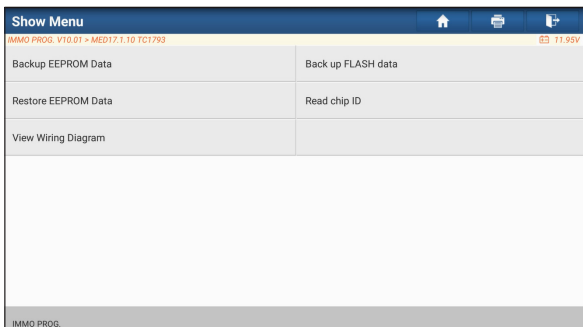

d. When below dialogue box appears, touch **OK**.

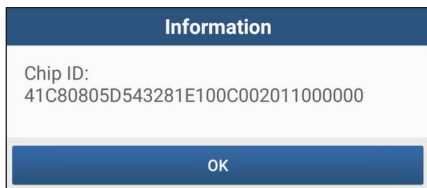

3. Backup data.

a. Touch **Backup EEPROM Data**.

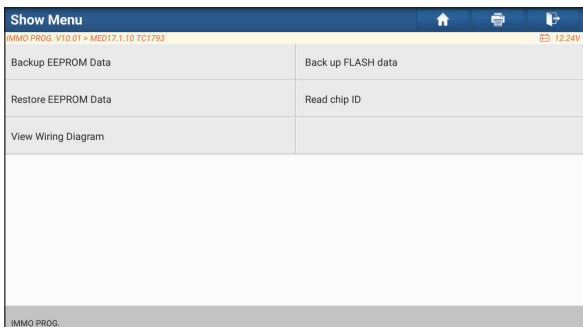

b. Enter the file name for EEPROM data.

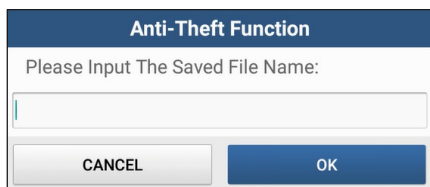

- c. Confirm the storage path, and touch **OK**.

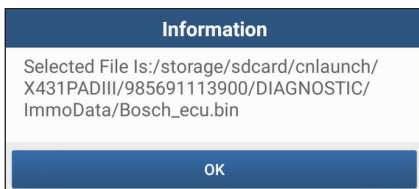

- d. Touch **OK**.

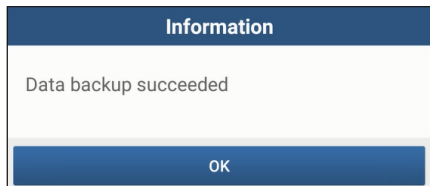

- e. Follow the onscreen instructions to backup flash data also when the above is done.
4. Restore EEPROM data.

! Stop: The EEPROM restoration applies only when you have encountered irrevocable faults.

- a. Touch **Restore EEPROM Data**.

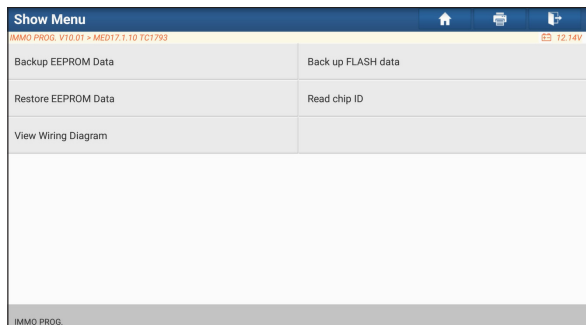

b. Touch Backup EEPROM file name.

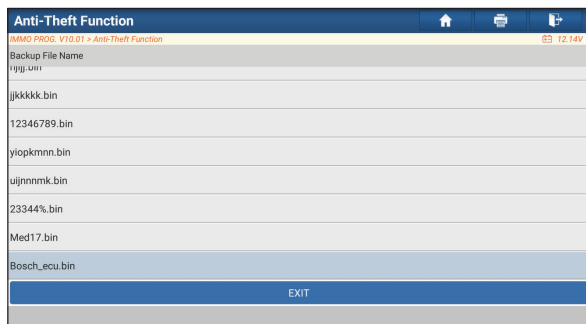

c. Confirm the selected Backup EEPROM file, and touch **OK**.

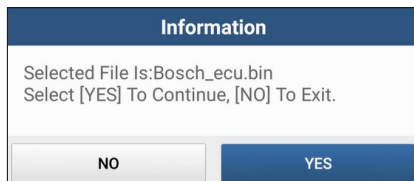

d. When the data is successfully restored, touch **OK**.

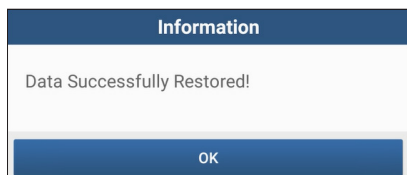

4. Software Upgrade

The software update function keeps your diagnostic software & App up-to-date, you can also use it to customize your frequently used software.

To update Diagnostic Software & APP:

1. On the main diagnostic screen, tap **Software Update** to enter the update center. Check the software you want to update, and then tap **Update**.

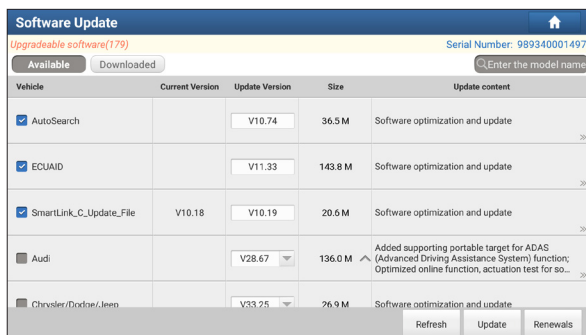

2. Once downloading completes, the software packages will be installed automatically.

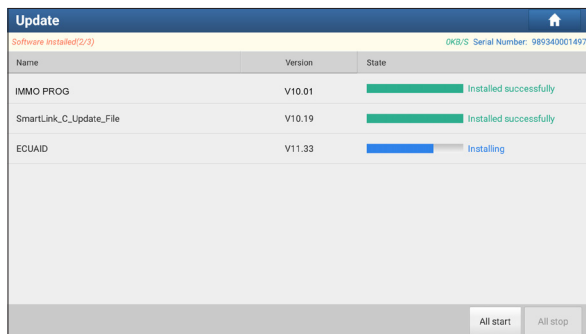

 Note:

- You may stop the process by tapping **Stop**, and tap **Continue** to resume the process later.
- In case of network connection failure, tap **Retry**.

3. You will see below dialogue box once the installation is completed.

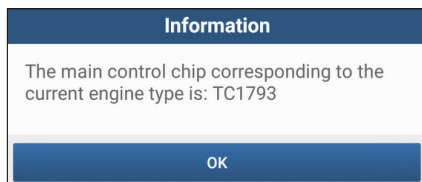

5. Warranty

Launch warrants its customer against any defects in workmanship and material of this product for 1 year after the date of delivery. Final judgment of defects shall be made by LAUNCH in accordance with procedures established by LAUNCH. No agent, employee, or representative of LAUNCH has any authority to bind LAUNCH to any affirmation, representation, or warranty concerning LAUNCH automotive meters, except as stated herein. The exclusive remedy for all automotive meters found to be defective is to repair or replace, and LAUNCH has no liability for any consequential or incidental damages.

The following cases are not covered in product warranty:

- Products with mechanical serial number being altered, removed, or defected.
- Products exposed to extreme conditions, such as excessive temperature, or moisture.
- Products damage resulting from external causes such as fire, dirt, sand battery leakage, blown fuse, theft or improper usages of electrical source.
- Products subject to accidents, mishandling, unauthorized alteration, abnormal usage or conditions, improper installation, repair or storage.

Order Information

Replaceable and optional parts can be ordered directly from your LAUNCH authorized tool supplier. Your order should include the following information:

1. Quantity
2. Part number
3. Item description

Customer Service

If you have any questions on the operation of the unit, please contact local dealer, or contact LAUNCH TECH CO., LTD:

Tel: +86-755-84557891

E-mail: overseas.service@cnlaunch.com